

BUCKS COUNTY HIGH SCHOOLS



23rd Year

BOB SANDS MEMORIAL

ALL STAR FOOTBALL CLASSIC

SPONSORED BY THE LIONS OF BUCKS COUNTY



SATURDAY JUNE 6, 1998
Council Rock High School
Swamp Road
Newtown, PA
KICKOFF AT 7:30 PM

OFFICIAL PROGRAM \$2.00

What is a Community Bank?

Community banking is a special mix of people, products, and services. The recipe might go something like this:

Start with an ample supply of friendly, knowledgeable employees. Add generous portions of competitive products, convenience, and advice. Stir in plenty of community involvement and shareholder value. Serves a whole community.

Switch to FNB - your COMMUNITY BANK!

THE *First* **NATIONAL BANK**
AND TRUST COMPANY
NEWTOWN, PENNSYLVANIA

(215) 860-9100

10 Offices in Central & Lower Bucks County



Visit us on the Web: www.fnbn.com



LIONS EYE BANK OF DELAWARE VALLEY



The Lions Eye Bank of Delaware Valley serves southeastern Pennsylvania, New Jersey and Delaware. Technicians at the Eye Bank are notified when an eye donor has died and they travel to the hospital to retrieve the eyes. Eye Bank technicians perform tests on the donor eyes to ensure that there has been no exposure to an infections disease, such as a virus, which could be passed to the recipient. The condition of each cornea is evaluated and the tissue is designated for transplantation or training and research purposes, depending on its condition.

DID YOU KNOW???

- » Corneal transplantation was the **first type** of transplant surgery performed - in **1905**.
- » Each year in the United States, 40,000 people receive corneal transplants, while an additional **5,000** people must be put on **waiting** lists because of donor shortages.
- » Corneal transplant surgery is the most successful type of transplant surgery. Over **90 percent** of corneal transplant operations are **successful** and restore sight.

WHO CAN BE AN EYE DONOR?

Anyone can become an eye donor. Age is no barrier and it doesn't matter if you wear glasses or have an eye condition. Most eye diseases do not affect the cornea, so even if you have a condition such as glaucoma or retinal disorder, you can still be an eye donor.

HOW CAN I BECOME AN EYE DONOR?

Complete the large portion of the attached pledge card and return it to the Lions Eye Bank of Delaware Valley. Make sure you keep the completed, small portion of the card with you at all times. Inform your family that you have pledged your eyes and any additional tissues or organs and that you want to have your wishes carried out.

QUESTIONS???

Lions Eye Bank of Delaware Valley
2000 Hamilton Street, Suite 202
Philadelphia, PA 19130-3813
215-563-1679 or 1-800-743-6667
Fax 1-215-563-3081

REGISTRATION CARD FOR DONATION OF EYES AFTER DEATH LIONS EYE BANK OF DELAWARE VALLEY

2000 Hamilton Street
Rodin Place - Suite 202
Philadelphia, PA 19130-9722



I hereby acknowledge my wish to donate my eyes immediately upon my death to the LIONS EYE BANK OF DELAWARE VALLEY, maintained for the preservation and use of human eyes or parts thereof, or for research seeking to prevent blindness. The disposition of the materials will be at the of their authorized personnel.

Name of Donor _____
(please print)

Signature of Donor _____

Mailing Address _____

City _____ State _____ Zip Code _____

Date _____ Date of Birth _____

Witness _____ Witness _____
(must be of legal age)

**PLEASE TEAR OFF AND ALWAYS CARRY WITH YOU
Lions Eye Bank of Delaware Valley, Inc. Identification Card**

This is a legal document under the
Uniform Anatomical Gift Act or similar laws.

As indicated below, I hereby make an anatomical gift, to take effect upon my death:

My eyes to the Lions Eye Bank _____ Only the following organs or parts: _____

Of Delaware Valley _____

Any needed organs _____ specify the organs or parts for the purpose of transplantation, therapy, medical research or education.

My body for anatomical study, if needed _____

Limitations or special wishes, if any _____

Signature of Donor _____

THIS PAGE IS SPONSORED BY THE SOUTHAMPTON LIONS CLUB

BUCKS COUNTY LIONS ALL STAR FOOTBALL COMMITTEE

*Let it be known to all that the greatest reward in a person's life
is knowing they have helped to improve
the quality of life for those who are less fortunate than ourselves.*

*Let it be known to all that Lion Robert Sands
has fulfilled his responsibility to this cause.*

*This committee, in recognition of Lion Bob Sands' dedication and loyalty
to the Lions, is proud to announce that this game
and all future All Star Games will be known as the
Bucks County Lions & Bob Sands Memorial Football Classic.*

The Bucks County Lions All Star Football Committee

Lion Robert Sands Accomplishments

*Lions Member, 22 years; President, Vice President, Secretary,
Board of Directors of Langhorne Lions Club;
Zone Chairman; Deputy District Governor; Membership & Retention Committee;
Leader Dog Committee; Bucks County Lions All Star Football Committee, 13 years;
Chairman, 2 years; Board of Directors, 13 years;
Bucks County Association for the Blind, Board of Directors, 6 years, President, 2 years.*



Listed below are the BUCKS COUNTY LIONS and LIONESSE CLUB whose combined efforts have made the ALL STAR GAME possible.

BUCKS COUNTY LIONS and LIONESSE CLUB

BENSALEM
BENSALEM LIONESSE
BRISTOL
CHALFONT
DELAWARE VALLEY
DOYLESTOWN
DUBLIN
DUBLIN LIONESSE
E. ROCKHILL TWP.

FEASTERVILLE
HILLTOWN TOWNSHIP
HOLLAND
HOLLAND LIONESSE
LANGHORNE
LANGHORNE LIONESSE
LEVITTOWN
MIDDLETOWN TWP.
MILFORD TWP.

MORRISVILLE
NEWTOWN
NORTHAMPTON
OTTSVILLE
PENNSBURY
PERKASIE
PLUMSTEAD
QUAKERTOWN
FALLS TOWNSHIP

RICHLANDTOWN
SELLERSVILLE
SOLEBURY
SOUTHAMPTON
SOUTHAMPTON LIONESSE
TOHICKON
TRUMBAUERSVILLE
WARRINGTON
YARDLEY-MAKEFIELD

IN APPRECIATION

The following list of individuals and organizations have contributed generously toward this project. We could not have done it without their support and contributions. There have been many, many, many individuals who worked and gave many hours of their time for this cause. However, it would be impossible to name them all. To everyone I want to extend my sincere appreciation and thanks.

Chairman
Joseph Warner

Bucks County Lions (Posters)
Johnson & Johnson, Inc. (Medical Supplies)
Wilson Sporting Goods (Game Footballs)
Bucks County Courier Times
Daily Intelligencer
Philadelphia Inquirer
Today Spirit
ASAP Printing (Game Tickets)
Bensalem H. S. (South Practice Field)
Council Rock H. S. (North Practice Field)
ASAP Printing (Program Printing)
Council Rock H.S. Athletic Director (Dennis Warg)
Council Rock H.S. Principal (Dave Yates)
Council Rock School Board
Coaches & Athletic Staff of all the High Schools
WNPV - Lansdale
WBUX - Doylestown
WBCB - Levittown
WRDV - Warminster
Warrington Motor Lodge
Old Anchor Inn, Wrightstown
The Locker Room Sporting Goods (Levittown)
Bucks County Lion & Lioness Members
Waste Management (Recycling Containers)
New York Giants (Football)
Dr. Burmeister
Dr. Anthony Rock, D.O.
The Forrestal at Princeton Hotel
Philadelphia Eagles
Wyndam Franklin Plaza Hotel
Dave Keeny - Head Coach, Kutztown U. (Speaker)
R.F. Marketing (Radio's)
Newport Data Products (Prize)
The Locker Room Sporting Goods (Pre Game Dinner)

LEADER DOGS FOR THE BLIND - ROCHESTER, MICHIGAN

Leader Dogs for the Blind was founded in 1939 by a group of Michigan Lions to train dogs to lead blind persons and provide facilities and means whereby blind persons may obtain Leader Dogs. The nonprofit organization is served by a national board of 30 trustees.

People with less than normal vision, over 16 years of age, in good health, emotionally stable and of good moral character may be eligible for Leader Dog training. The students live under constant supervision of competent instructors during a four week training period. An instructor and house-mother are on duty at all times. Training is conceived as a re-education emotionally and physically to a new way of effective living.

After a period of "getting acquainted" with his/her Leader Dog, the student is taken to the small, quiet town of Rochester where actual pedestrian training is begun. In progressive stages adjustment to more hazardous traffic conditions is accomplished through training on busy streets, in the heavy traffic and the hurrying crowds of Birmingham and Royal Oak, Michigan & Detroit.

At the end of four weeks training with a Leader Dog, the hesitant blind student is changed to an erect confident person who had challenged and conquered one of life's severest handicaps.

A Leader Dog enjoys its superiority. It is not just a dog, it is a Leader Dog, capable of making decisions that protect the safety of the owner. The fledgling dog must be from one to two years old, in good condition and willing to accept responsibility. Dogs must be positively friendly even to strangers. German Shepherds, Labradors and Golden Retrievers are commonly trained as Leaders. All dogs are contributed. Leader Dogs know the rules of safety. Stop-Look-Listen- then cross the street briskly. Leaders are taught to respect traffic, vehicular and pedestrian, and will respond to the given command only when the way is clear. Most dog owners say the dog is a family pet and romps with the children but the instant they put on the harness the dog is all business.

If you know anyone who could use a Leader Dog, contact your local Lions Club. The training as a student, food, lodging, and the Leader Dog are all at no cost to a qualified blind person. Usually, transportation to the school and back is paid for by the Lions Club.

BEACON LODGE CAMP FOR THE BLIND

Beacon Lodge is situated on State Route 103, two miles southwest of Newton Hamilton, PA, along the beautiful Juniata River. The hills and mountains of Central Pennsylvania surround the camp, making it a secluded place for those that require rest and an atmosphere to enjoy the activities of a camp program.

The camp occupies a 567 acre estate through which flows a babbling brook. The Main Lodge where the women campers are housed, is a twenty-eight room structure with comfortable sleeping quarters for forty persons. The dining hall, with seating accommodations for 150, and the large modern kitchen are also located in the Main Lodge. The large living room with a huge fireplace, a piano, and an electric organ is a favorite spot for adult campers. The room has a balcony with a braille library and talking books. Close by is Tarentum Hall with a snack bar and a second floor with facilities for fifteen persons. Female campers and staff are housed here. 14B Dormitory is a one floor cement block structure with accommodations for 48 male campers and staff. 14B Dormitory has accommodations for four married couples. The infirmary consists of nurses quarters, dispensary, and rooms for patients assigned, and married couples.

In Childrens Village there are twelve cement block cabins well ventilated and screened with complete bathroom facilities in each cabin and individual storage cabinets for personal items. Each cabin will accommodate 6 children and their counselors. A larger building provides kitchen and dining room facilities. It is also a food storage building, and living quarters with an office for the unit director. In the summer of 1975, a brand new air conditioned infirmary with nurses quarters and a boys and girls ward was dedicated to the late Paul Mahady, a Pennsylvania State Senator and a Past International Director of Lions.

This year a new activity building will be opened in the village. A physician in nearby Mount Union is available at the camp and the modern Huntingdon and Lewistown Hospitals are also available in time of need.

All guests are free to do the things they enjoy most. Beacon Lodge attempts to satisfy two types of campers. Those who want to rest and relax among old friends and to make new ones. Those who prefer a more active type of vacation may select a program of varied activities. There is a choice of motorboating, rowing, hiking, shuffleboard, roller skating, bowling, campfire programs, picnics, overnight hikes, mountain climbing, bus rides, baseball (with a beeping ball), wrestling, field events, bike riding, shopping tours, arts & crafts, dancing, and swimming. You must visit the camp to truly appreciate it. The 42 members of the Board of Directors are very proud that they have been able to keep the weekly fee to \$125.00. The actual cost is \$280.00 per week. Many Lions Districts pick up the tab for utilities and maintenance, thus enabling the camp to operate at such a low fee.



HEARING CONSERVATION / HEARING RESEARCH

A quotation from Helen Keller. . . .

"Deafness, by fettering the powers of utterance, cheats many a persons birthright to knowledge. How can people pick up words and weigh their value if they lack the foundation on which knowledge is built?"

Hearing Conservation revenue supports the following:

1. Provide hearing examinations for needy children and adults alike.
2. Provide hearing testing equipment for schools, clinics, etc.
3. Provide medical or surgical services.
4. Furnish, repair, or replace hearing-aids when necessary for hard of hearing children and adults.
5. Provide needy individuals with batteries, aids, and special devices.
6. Furnish equipment for classroom use with hearing impaired children.
7. Provide financial assistance to families with hearing impaired children in need of special education.
8. Provide video tapes, films, etc. for deaf individuals.
9. Assist with vocational and employment services.

Hearing Research collects money to award grants for the best proposals submitted by doctors, hospitals, and universities in order to improve all aspects of the hearing problems.

CAMP KIRBY

Camp Kirby sprawls over rolling fields and woodlands, high above the Delaware River, in beautiful historic Bucks County. It is located in Upper Black Eddy, 35 miles north of Philadelphia on route 611. At Ferndale Hotel, turn right, drive three miles to Camp Kirby.

Camp Kirby was designed to meet a definite need. The proper educational and recreational facilities are available for the hearing handicapped campers. A professional staff of experienced counselors assist and train the campers.

Trips are taken to nearby sites where pages from their history books come alive through the interpretation of counselors trained in teaching the hearing handicapped. Each boy or girl's education will grow in a Summer Camping environment.

Overnight campouts create an atmosphere of fun, excitement, the thrill of spotting deer at night and seeing other wildlife. These experiences not only are shared around the campfires, but memories to cherish for years to come.

As each camper participates in various activities, an educational program involving the language and vocabulary of camp life is pre-sented by counselors. Hiking, volleyball, swimming, riflery, cookouts, riding and nature lore are a few of the many activities to help enrich the camper's life.

Free time to participate in individual activities such as gold, fishing and archery help teach self-responsibility and self-discipline.

Camp Kirby consists of 27 acres and has a stream running through the land. The camp has its own well for water. The physical facilities include the following:

six cabins for campers
infirmary
bathrooms for boys & girls w/showers
large living room
office

recreation room
fireplace with outdoor grill
swimming pool
home for caretaker
cabin for director

1998 ALL-STAR FOOTBALL GAME COMMITTEE

Executive Board:

Joe Warner, Chairman (Northampton)
 Bob Elsner, 1st Vice Chairman (Chalfont)
 Sam Turner, 2nd Vice Chairman (Tohickon)
 Frank Kolanko, Treasurer (Southampton)
 Faith Costantini, Secretary (Southampton)
 Frank Kolanko, Past Chairman (Southampton)

Committee Chairmen:

Frank Kolanko, Game Program (Southampton)
 Bill Redstreak, Game Tickets (Southampton)
 Half-Time Coordinator
 Faith Costantini, Food (Southampton)
 Al Santopietro, Banquet (Northampton)
 Jim Davis, Publicity (Chalfont)
 Gloria Suppin, Cheerleaders (Southampton)
 Frank Kolanko, Fund Raising (Southampton)
 Jim Davis, Photographer (Chalfont)
 Sam Costantini, Tee Shirts (Southampton)
 Tom Edmunds, Tee Shirts (Warrington)
 Joe Warner, Facilities Coordinator (Northampton)
 Jim Kapsak, Pins (E. Rockhill)

Honorary Board:

* Robert Sands (Langhorne)
 Willard Conway (Falls)
 * Dick Wisneski (Quakertown)
 * Bill Craver (Doylestown)
 Dr. Donald Sprole (Perkasie)
 * Jack Wilhelm (Richlandtown)
 * Charles Myrtetus (Warrington)
 * John Witsch (Southampton)
 * Deceased

Game Coordinators:

NORTH - Don Young
 Quakertown Lions

 SOUTH - Mike Clarke
 Morrisville H.S.

Lions All-Star Game History

Year	Played At	Chairman
1976	Neshaminy	Robert Sands (Langhorne)
1977	Poppy Yoder, Perkasie	Robert Sands (Langhorne)
1978	Bensalem	Robert Sands (Langhorne)
1979	Pennridge	John Witsch (Southampton)
1980	War Memorial, Doylestown	John Witsch (Southampton)
1981	War Memorial, Doylestown	Clifford Crose (Newtown)
1982	War Memorial, Doylestown	Clifford Crose (Newtown)
1983	War Memorial, Doylestown	Charles Myrtetus (Warrington)
1984	War Memorial, Doylestown	Robert Kogut (Tohickon)
1985	War Memorial, Doylestown	Lin Fehnel (Newtown)
1986	War Memorial, Doylestown	Lin Fehnel (Newtown)
1987	War Memorial, Doylestown	George Morris (Levittown)
1988	Del Val College	George Morris (Levittown)
1989	Neshaminy	Walter Bitterlich (Northampton)
1990	Bensalem	Walter Bitterlich (Northampton)
1991	Bensalem	Walter Bitterlich (Northampton)
1992	Neshaminy	Samuel Costantini (Southampton)
1993	Pennridge	Samuel Costantini (Southampton)
1994	Bensalem	Ken Moore (Bensalem)
1995	Wm. Tennent	Ken Moore (Bensalem)
1996	Wm. Tennent	Frank "Socks" Kolanko (Southampton)
1997	Bensalem	Frank "Socks" Kolanko (Southampton)
1998	Council Rock	Joseph Warner (Northampton)

It is impossible to list all the names of all the people who gave of their time to make this annual Bucks County Lions All Star Game a success.

Those that are listed here are the people who initiated ideas and saw that they were carried out successfully. These are the people, without whom, we would never have been able to make this evening a reality. To the hundreds of others, who will remain nameless, we say, "THANK YOU"



Lions Camp Kirby
For Deaf Children



For further information regarding Lions Camp Kirby, please contact the Director of Registration:

Lion Katherine Geroni
 P.O. Box 318
 Dublin, PA 18917
 (215) 249-3710 (Voice Only)

DIRECTIONS



Directions:
 From Philadelphia: Take Rte. 611 north to the town of Ferndale (approx. 12-13 miles north of Doylestown). Turn right at traffic light onto Church Hill Rd. (Name of road changes to Narrows Hill Rd.) Camp Kirby is 3 miles on left.

From Valley Forge: Take Rte. 202 north to Rte. 611 north. Proceed as above.

From Levittown area: Take Rte. 413 north to Rte. 611 north. Proceed as above.

OUR GOALS:

- ◆ To Promote Social Growth
- ◆ To Promote Personal Growth
- ◆ To Promote Creativity
- ◆ To Promote Self Expression
- ◆ To Promote Self Confidence

OUR PROGRAMS:

- ◆ Outdoor Activities
- ◆ Nature Studies
- ◆ Arts & Crafts
- ◆ Computer Skills
- ◆ Talent Competitions
- ◆ Communication Skills
- ◆ Storytelling
- ◆ Campfires



LIONS
CAMP
KIRBY



meyers
family restaurant

Breakfast, Lunch, Dinner
7 days a week, 7 am - 10 pm

- Banquet facilities for 10 - 250 people
- Retail Bake Shop on premises
- Sunday Breakfast Buffet

ROUTE 309 • QUAKERTOWN, PA
536-4422



QUAKERTOWN LIONS

BEST WISHES NORTH ALL-STARS

Regular Meeting
Second & Fourth Wednesday



SOUTHAMPTON LIONS CLUB

P.O. BOX 152
SOUTHAMPTON, PENNSYLVANIA
Meets Second and Fourth Wednesday 7 PM
Churchville Inn • Southampton, PA 18966
(New Members Welcome)!

GOOD LUCK BUCKS COUNTY ALL STARS

COMMUNITY SERVICE

BOY SCOUTS
BETHANNA HOME
SOUTHAMPTON LIBRARY
TAMENEND PARK
SCHOLARSHIPS
SOUTHAMPTON GIRLS CLUB



1961 - 1998

President - Paul S. Gunther
Secretary - Peter Hughes
Treasurer - Jerry Lukens



CHARITABLE ORGANIZATIONS WE SUPPORT

BUCKS COUNTY ASSOC. FOR THE BLIND
WILLS EYE HOSPITAL
PENNA. HEARING AND DEAF
CAMP KIRBY (DEAF)
BEACON LODGE (BLIND)
LEADER DOG FOR THE BLIND
PENNA. EYE RESEARCH
DELAWARE VALLEY EYE BANK
L.C.I.F.
AMERICAN DIABETES
JUBENILE DIABETES
ST. LUCY DAY SCHOOL (BLIND)

**OUR
FALLS TOWNSHIP
LIONS CLUB
THANKS**

**THE BUCKS COUNTY
ALL-STARS**
FOR THEIR KIND AND GENEROUS
DONATION OF THEIR TIME AND
EFFORT TO HELP THE LIONS IN
THEIR WORK TO HELP THE BLIND
AND SIGHT HANDICAPPED



**AL GIBSON, President
LOUIS SANCINITO, Secretary**

**IF
YOU
THINK
BUCKS COUNTY
ASSOCIATION FOR
THE BLIND BENEFITS ONLY**

THE BLIND, PLEASE TAKE A CLOSER LOOK

The Bucks County Association for the Blind offers far more than meets the eye. Our programs educate and inform our community about eye care, eye disease, and eye safety. We provide pre-school vision and hearing screening. We distribute special products to help individuals with low vision. And we offer support and counsel for those concerned and affected by the vision-loss of a family member or a friend.

Of course, we have regularly been furnishing special services to the blind and the visually impaired for over fifty years. Our programs and services help those who are blind to lead full, productive, and independent lives. We are able to do this because you see fit to support us generously.

We look forward to your continuing help. Send us a tax-deductible donation, today. See how good it makes you feel!

BUCKS COUNTY ASSOCIATION FOR THE BLIND

400 Freedom Drive, Newtown, PA 18940

phone (215) 968-9400 fax (215) 968-2127

Independent Travel Through Quality Instruction



Leaders Dogs for the Blind® has been providing trusted Leader Dogs to blind and visually impaired people for over 50 years. Over 10,000 blind travelers have found the freedom a Leader Dog can offer. Although each team costs over \$15,000 the service is provided free of charge to qualified blind travelers worldwide. If you or someone you know would like further information on how a Leader Dog can be obtained, or if you wish to assist us in maintaining our services to the blind, call or write for information:

Leader Dogs for the Blind®

P. O. Box 5000
1039 S. Rochester Road
Rochester, MI 48307-3115
Toll Free:
888-777-5332



Afton
DELI

- TAKE OUT
- CATERING
- GOURMET

"THE BEST HOAGIES IN YARDLEY"
7E. AFTON AVE. · YARDLEY, PA 19067
Walter J. Bitterlich, Proprietor
PHONE: (215) 493-9030 · FAX (215) 369-0223

Stephenson's Auction

1005 Industrial Blvd.
Southampton, PA 18966
322-6182

Offers a complete Auction Service
Handling Estates, large & small
On-Site or in our Gallery
Auctions - Appraisals - Liquidations



Delaware Valley Registers, Inc.

P.O.S. Systems • Supplies • Service
997-1776 822-1724

335 W. Butler Ave. (Route 202), Chalfont, PA 18914



**WM. ROWEN GRANT
FUNERAL HOME, INC.**

Personalized Pre-Arrangement Counseling -
With No Obligation

(215) 355-6050

Street Road and Second Street Pike
Southampton, PA 18966

Wm. Rowen Grant, Jr.

**WARDS
RENTS**

TOOLS & EQUIPMENT
SALES • SERVICE • RENTALS
Everything for home & industry

Special Events

Everything for any
special event or party
Tents • Tables • Chairs

322-3200
1-800-536-WARD

816 Second Street Pike Southampton, PA



322-7775

Angelo's

*Fine Italian Restaurant - Pizza
Family Dining*

*Nino Panno
Andrea Panno*

*441 Second St. Pike
Southampton, Pa. 18966*

**The
General
Insurance
Agency**
INCORPORATED

OFFICE: (215) 884-8414
FAX: (215) 884-7364
PAGER: (610) 305-0411

WESLEY K. FRITZ
VICE PRESIDENT

JENKINTOWN STATION BUILDING
115 WEST AVE., SUITE 200
JENKINTOWN, PA 19406



Ollard Stationery

963 STREET ROAD
355-2222

SOUTHAMPTON

Next to the Library & Fire House 13



THE
**LANGHORNE
LIONS CLUB**

CONGRATULATE THE
**NESHAMINY REDSKINS
ALL STARS**

PRESIDENT

Joe Kazanjian

VICE-PRESIDENT

Rich DiGregorio

SECRETARY

Ron McCarty

TREASURER

Clem Piscitelli



Meeting every 2nd and 4th Thursday at the Mill Race Inn

Route 532, Holland, PA 18966

NEW MEMBERS ALWAYS WELCOME

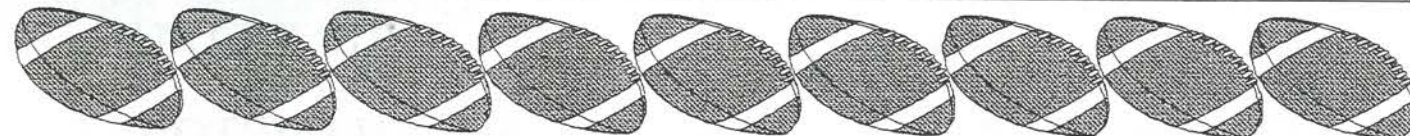

BUCKS COUNTY
SPORTS

Thursday
April 16, 1998

Talent show

Council Rock to host All-Star football game

North roster

Archbishop Wood: Mike Becker, QB; Dan Boyle, FB; Mike Lacey, LB; Matt Lorditch, SE; Ryan Rupprecht, DB; Matt Schaub, OL; John Traczykiewicz, SE.

Central Bucks East: Mike Ben-

scoter, OL; Tony Bevivino, WR; Paul Marini, OL; Brian Song, OL; Manny Stoupakis, RB-DB; Scott Toka, DL. **Central Bucks West:** Nick Crognaile, DE; Adam Domurad, OL; Mario Palena, WR-DE; Corey Potter, DB; Jack Shackleton, DE; Dave Titus, SE-DB; Greg Ward, TE; Scott Warden, RB; Jason Yaich, OL.

Council Rock: Bill Chieffo, RB-DB; Ed Johnson, OL; Jack Smith, DB; Erik Warg, FB; Andrew Wertz, LB; Chris Yates, P.

Pennridge: Mike Bunting, K; Matt Donohue, DL; Keith Moore, QB; Ryan Shaak, DE; Floyd Turner, DB.

Quakertown: Joe Ewashko, WR; Mike McGouldrick, DL; Brian Miller, TE; Todd Schulberger, LB. **William Tennent:** Keith Crowell, RB-DB; Lou Fanelli, FB-LB; Rob Verhelle, OL.

Head coach: Mike Ortman (Council Rock). **Assistant coaches:** Vince Bedesem, Bruce English, Sam Evans, Jeff Hollenbach, Bud Ortman, Shawn Ortman (Council Rock).



Crowell

By Andy Vineberg

Courier Times
avineberg@calkinsnewspapers.com

NEWTOWN — Council Rock High School football coach Mike Ortman has been involved in enough of these Bucks County All-Star football games to know how much fun they can be. Bensalem coach Biz Keeny will be finding out for the first time.

But both men know they will have a ton of talent to work with when practices begin late next month.

Ortman and his staff will coach the North, and Keeny and his staff will guide the South at the 27th annual Bucks County Lions Clubs Bob Sands Memorial All-Star Football Game. Council Rock, which added stadium lights before last season, will host the game for the first time on Saturday, June 6, at 7:30 p.m.

The game is about showcasing the best senior football talent in Bucks County. But it's also about raising money for charity.

In the 22 years the Lions Club has sponsored the game, it has raised more than \$275,000 in charity. Last year's game raised \$17,000, including more than \$4,000 for the Bucks County Blind Association.

The North leads the series, 16-7-3, and has won five of the last seven games. The teams tied, 28-28, last year.

This will be Ortman's fourth time as head coach. He went 0-2

with the South when he was head coach at Morrisville, and he led the North to a 20-12 victory as Rock coach in 1992.

"The neatest part is getting to coach kids you've game planned against during the year," Ortman said. "You don't have to hide any bodies out there. Most of the players are real top-caliber kids, and a large majority of them will play ball in college."

One star Ortman won't get the chance to coach is CB West's Dave Armstrong, who opted to play in the Big 33 game between Pennsylvania and Ohio All-Stars.

Keeny, who guided Bensalem to its first winning season in five years as a rookie head coach last fall, said coaching in the game will remind him of his days as a college assistant at Kutztown.

"It's almost like really being back at college," said Keeny. "We'll have pretty good players at every position."

The South roster appears stacked at the skill positions, with Courier Times Player of the Year Jim Dietz of Neshaminy at quarterback, Bensalem's Keith Davis at running back and a star-filled crop of receivers, led by Bensalem's Temple University-bound Krishan Lewis.

The North will counter with some dangerous skill position players of its own, including running backs Keith Crowell of William Tennent and Dan Boyle of Archbishop Wood.

South roster



Dietz

Bensalem: Keith Davis, RB-DB; Rob Dunner, QB-DB; Aquil Flythe, TE-DE; Krishan Lewis, WR-DB; Nick Lombardo, OL-DL; Steve Mason, FB-DL; Randy Thomas, FB-DE; John Tutino, OL-LB.

Conwell-Egan: John Hanes, OL-DL; Josh Secoda, TE-LB.

Harry S Truman: Ryan Cunningham, OL-DE; Antoni Fobbs, FB-DL; Kevin McArdie, WR-DB; Jeffrey Rogers, RB-DB; Jason Scheerer, WR-DB; Don Thomas, OL-DL.

Morrisville: Bob Angelini, RB-DB; Brian Fennimore, OL-DL; Jermaine Livingston, WR-DB.

Neshaminy: Adam Behar, WR-DB; Jim Dietz, QB; Frank DiSandro, RB; Jason Jonigkeit, WR; Jim Kelly, DB; Mike Kelly, DB; Greg Mininger, OL-DL; Kevin Mullins, LB; Mike O'Brien, TE-LB; Josh Vetter, K.

Pennsbury: Josh Burden, WR-DB; Jim Clayton, OL-DL; Paul Copenhafer, TE-DE; Brad Morgan, OL; Keith Johnson, RB-DB; Craig Lough, K-P; Jim Roberts, WR-DB; Dave Schimpf, QB-DB; T.J. Tignor, FB-LB.

Head coach: Biz Keeny (Bensalem). **Assistant coaches:** Tony Dragani, Lorenzo Henderson, John Karpinski, Barry Kline, Dave Nolter, Michael Pacitti (Bensalem).

Thank You Courier Times - Intelligencer - Record

Quakertown Football Booster Club
Congratulate The Panther All-Stars



JOE EWASHKO

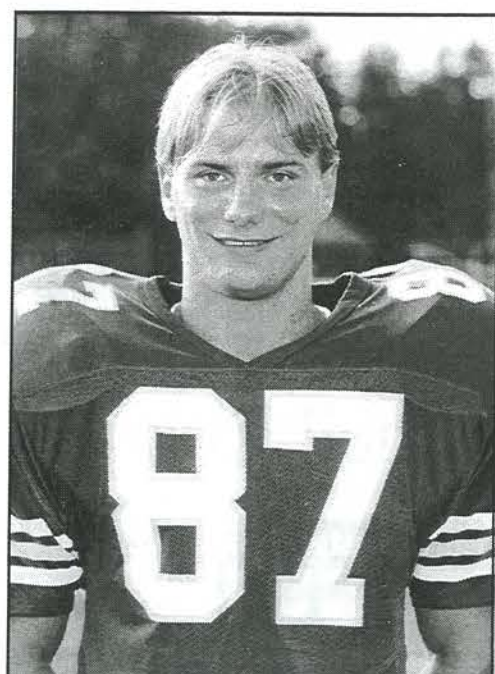

BRIAN MILLER

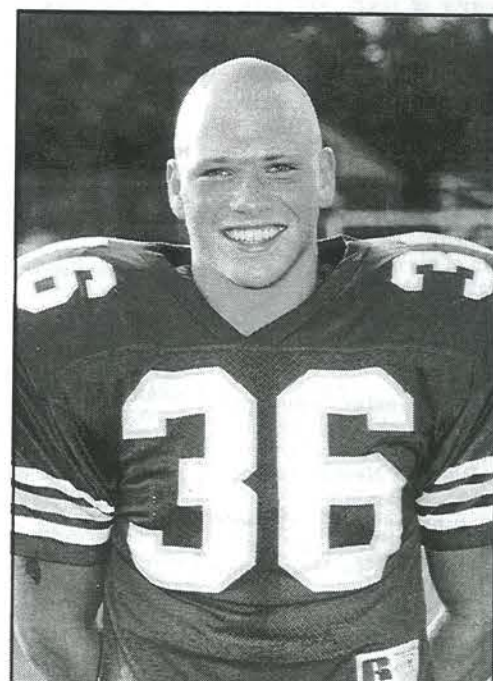

TODD SCHULBERGER

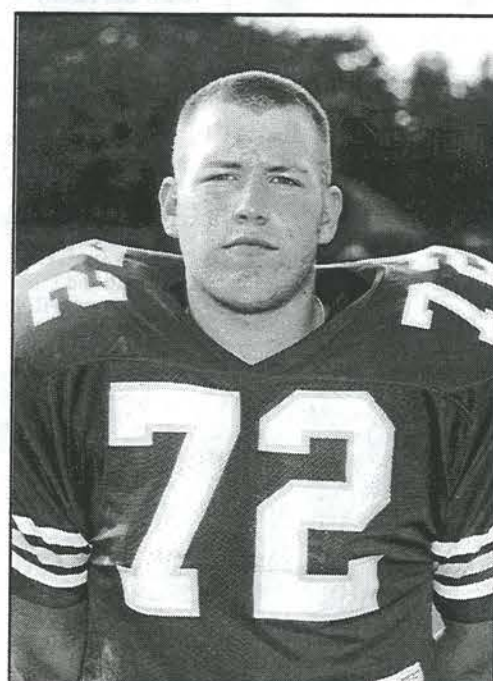

MIKE MCGOULDRIK



The 1998
All-Star Committee
extends a
"Big Thanks"
to "everyone"
for their support
in making this year's
ALL-STAR GAME
so successful.



The All Star Committee would like to extend a special "THANK YOU" to Dan Taylor for the many years he has served as the Master of Ceremonies for the Football Banquet, the Public Address Announcer at the Football Game and for his assistance at Press Nite. Dan is a graduate of William Tennent High School, Bucks County Community College and Temple University. For many years, he has been associated with local radio and is currently a free lance commentator on the Suburban Community Television Show "Sportsline". Again, many thanks to Dan for all he has done to make the All Star Game a success.

BUCKS COUNTY LIONS CLUBS

BOB SANDS MEMORIAL All Star Football Classic



We Serve



- Full Page (8 x 10 1/2) \$ 150.00
- 1/2 Page (8 x 5 1/4) \$ 90.00
- 1/4 Page (4 x 5 1/4) \$ 60.00
- 1/8 Page (4 x 2 5/8) \$ 35.00
- Patron (name) \$ 2.00

NOTE: Please Use Bottom for Copy

We the undersigned agree to use _____ pages advertisement in the Bucks County Lions Clubs Book for which we agree to pay _____ Dollars.

Company/Individual _____

Address _____

Phone No. _____

Authorized by _____ Received by _____

Lions Club _____

Make checks payable to Bucks County Lions Clubs Football Fund.

The Bucks County Lions Clubs reserves the right to reject any advertisement not consistent with the objectives of the Lions Clubs. This space is taken as an indication to help foster these objectives. Any verbal pledges are void.

Address all inquiries and communication to 1281 Dennis Road, Southampton, PA 18966 or call 357-0244.

- 1 Full Page
- 1/2 (One Half) Page
- 1/4 (One Quarter) Page
- 1/8 (One Eighth) Page
- Patron

FRANK KOLANKO
1281 DENNIS RD.
SOUTHAMPTON, PA
357-0244

LIONS CLUB _____ Seller _____

White - LIONS Yellow - CUSTOMER

THE NEWTOWN LIONS CLUB CONGRATULATES THE BUCKS COUNTY ALL STARS



**JUST AS THESE FINE YOUNG MEN WORK AS A TEAM THE
LIONS OF NEWTOWN WORK TO SUPPORT THE FOLLOWING
CHARITABLE ORGANIZATIONS.**

PA EYE RESEARCH FOUNDATION

PA HEARING FOUNDATION

CAMP KIRBY FOR THE DEAF

BEACON LODGE FOR THE BLIND

LEADER DOG FOR THE BLIND

DELAWARE VALLEY EYE BANK

BUCKS CNTY ASSOC FOR BLIND

WE SPONSOR THE FOLLOWING:

SCHOLARSHIPS

STUDENT OF THE MONTH

NEWTOWN RUN FOR SIGHT

LIONS QUEST

IF YOU HAVE AN INTEREST IN JOINING US IN OUR MANY COMMUNITY ACTIVITIES BY GIVING OF YOUR TIME AND CREATIVE ABILITY, CONTACT ANY OF THE FOLLOWING NEWTOWN LION OFFICERS

PRESIDENT: Len Adamusco 968-1675

VICE PRESIDENT: Lin Fennel 536-8304

SECRETARY: Marion Satterthwaite 968-3354

TREASURER: George Carter 493-8349

Congratulations and Good Luck to Both All Star Teams



PENNSBURY LIONS CLUB

Lorraine Baker
George Davenport
Lydia Kaplan
Bruce Miller
Charlie Rich
Jack St. Pierre

Phil Cammarata
Cathy French
Thelma McKeown
Cliff Ousley
Newton Richards
Phil Tyler

Sue Corti
Bruce Goulet
Mike McLaughlin
James Piscopo
Joan Smith
Nancy Zavacky

Shirley Castaldi, **PRESIDENT**
Dennis Hemphill, **SECRETARY**
Barry Engroff, **TREASURER**
E.V. Corti, **PDG**



CONGRATULATIONS 1998

President
ART D'ANGELO

ALL-STARS

Secretary
Dr. SCOTT WALKER

from

Chalfont Lions Club

Serving our community
for over 60 years



MEETINGS • 2nd & 4th Wednesday
7:00 P.M.
Best Western Motel
Route 202
Montgomeryville, PA

☆ Charitable organizations Supported

- ☆ American Flag Program
- ☆ Beacon Lodge
- ☆ Bucks County Blind Association
- ☆ Bucks County B.S.A.
- ☆ Camp Kirby
- ☆ Delaware Valley Eye Bank
- ☆ Leader Dog
- ☆ Lenape Valley Recreation Assoc.
- ☆ Pennsylvania Speech & Hearing
- ☆ Sight First
- ☆ Scholarships

☆ Community Service

- ☆ Bridge & Gazebo - Chalfont Borough
- ☆ Easter Egg Hunt
- ☆ Christmas Tree Sale
- ☆ Senior High Scholarship
- ☆ Junior High Scholarship
- ☆ Joe Evans Trail



Congratulations and
Good Luck
to the
PENNRIDGE ALL-STARS
from



DUBLIN LIONS CLUB

*Regular Membership Meeting
Second and Fourth Monday
at the*

DUBLIN STAR DINER



Mothers Against Drunk Driving
Bucks County Chapter

*Please Have a safe & fun summer,
don't drink & drive!*



Join Bucks County MADD Today!



Your membership strengthens MADD's voice. Your tax-deductible contribution supports MADD's community awareness and education, victim assistance and advocacy programs.

Membership:

- \$10 Senior Citizen/Student
- \$20 Individual Member
- \$40 Family Member
- \$150 Organization Affiliate

Name: _____

Address: _____

Mail to: MADD, P.O. Box 1203, Newtown, PA 18940
(215) 741-1667

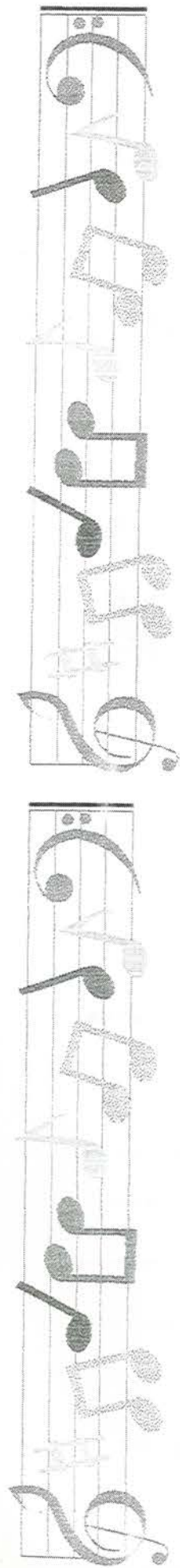

EAST ROCKHILL LIONS CLUB OLDIES DANCE



Perkasie Fire Hall
Saturday, Feb 27, 1999
Guest D.J. - The Music Medic
Donation \$11.00 Per Person
Refreshments Served

B.Y.O.B.
For Tickets Call:
DENNY KRAMSE
(215) 529 7662

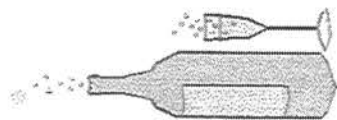
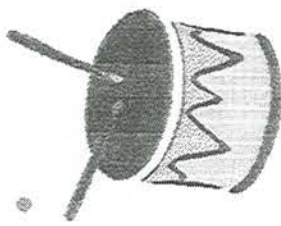
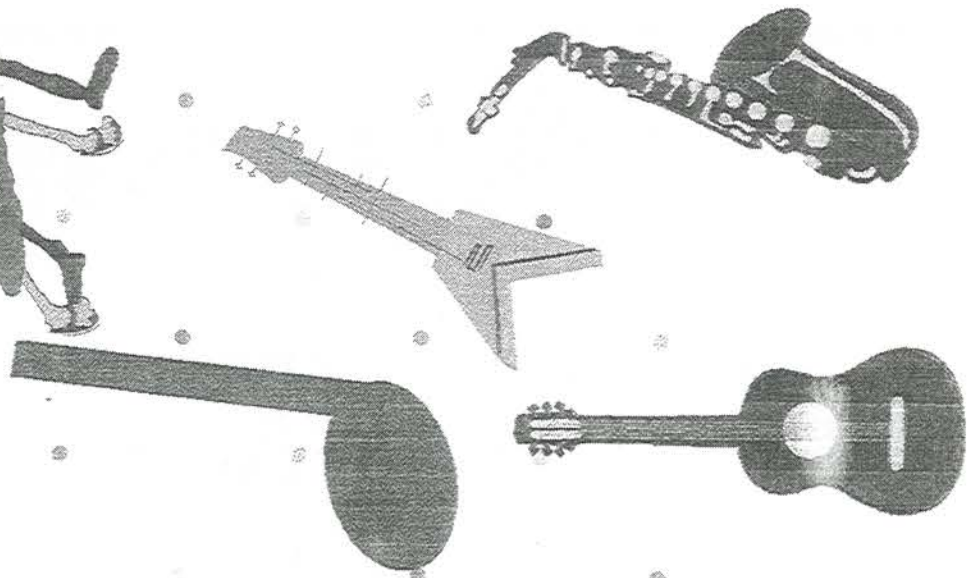
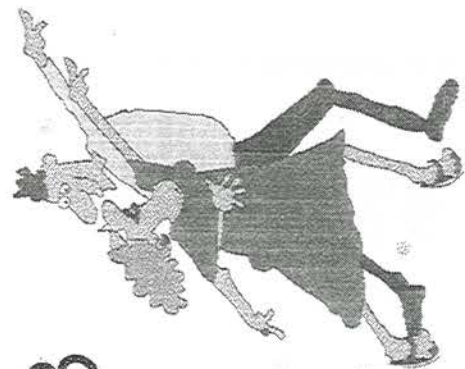

Good Luck 1998 PENNRIDGE ALL-STARS

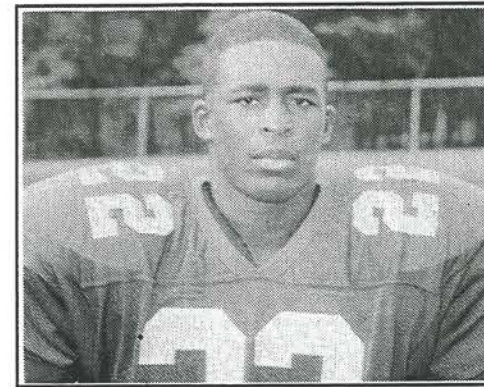

FLOYD
TURNER

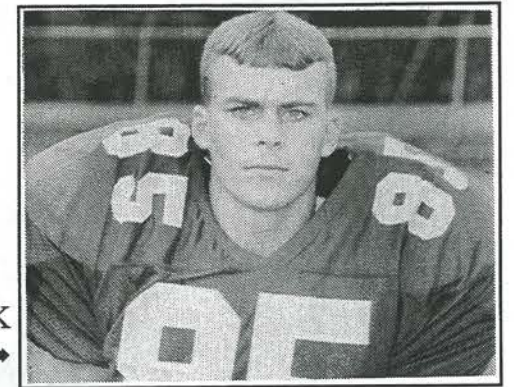

RYAN
SHAAK

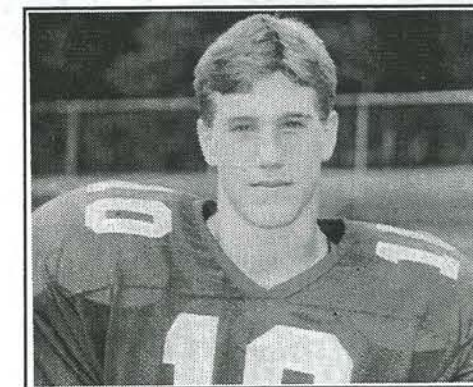

KEITH
MOORE

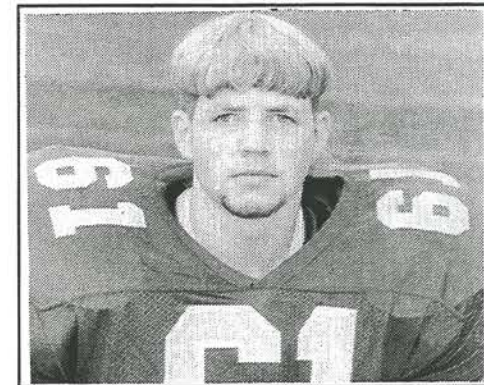

MATT
DONOHUE



MIKE
BUNTING

From The Pennridge Booster Club

Middletown Township Lions Club

922 S. Woodbourne Road
Levittown, Pennsylvania 19056

*Congratulations
to all the players*

Good Luck in the Future



President, Albert Sutter
Secretary, Erich Wendell

**GOOD LUCK TO
CENTRAL BUCKS
(EAST-WEST)
ALL-STARS**



**FROM
DOYLESTOWN
LIONS CLUB**

MEETINGS

2nd & 4th Thursday • 6:30 PM
SKIPPY CILANTRO'S • 739 N. Easton Road • Doylestown, PA



*L-R Bob Kocut - Mike Clarke (South Coordinator)
(Final Check Out List)*



*L-R Dan Taylor and Larry Greene
(Talking Football)*

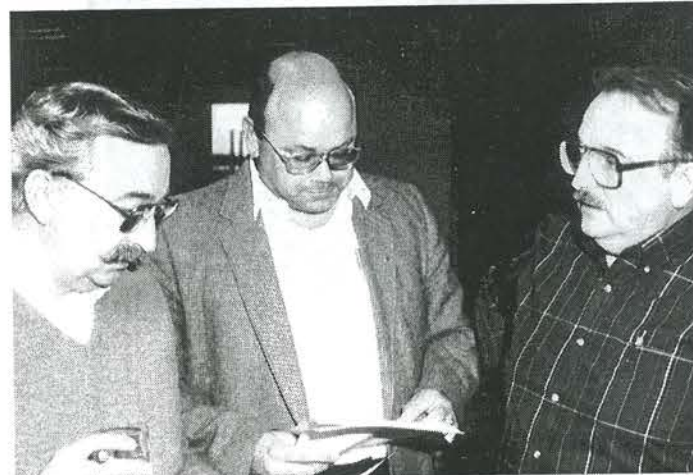

*L-R Gene Kennedy - Walter Bitterlich - Bob Kocut
(Looking Over Game Duties)*



*Dick Wisneski (North Coordinator for many years)
(West Chester Hall of Fame Player)*



*L-R Hank Johns (HST) Larry Greene (C.B.E.) & John Chaump (Nesh)
(Past Coaches Talk)*



L-R All-Star Lion (Amy Kolanko) and Frank (Socks) Kolanko

**Congratulations
and
Good Luck
to
North and South
ALL - STARS**



**YARDLEY MAKEFIELD
LIONS CLUB**

*Regular Membership Meeting
2nd & 4th Tuesday: 7:00 PM
Yardley Inn*

Congratulations and
Good Luck to
Both **ALL-STARS** Teams
from



Walter J. Mecleary, President
John Rodgers, Secretary

Holland Lions Club

P.O. Box 623
Holland, PA 18966

**ARCHBISHOP WOOD
CATHOLIC H. S.
PARENTS ASSOCIATION**
PROUDLY PRESENTS
THE 1997 VIKING ALL-STARS



MICHAEL BEJZAK #35
MIKE IS ATTENDING
EAST STROUDSBURG U.
AND A REDSHIRT
FRESHMAN

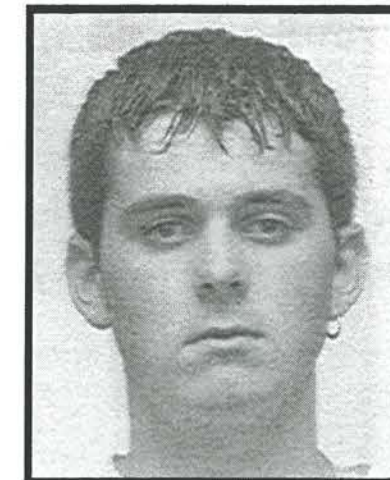

MICHAEL GOGOLA #75
MIKE IS ATTENDING
PENN STATE U.
OGONTZ CAMPUS

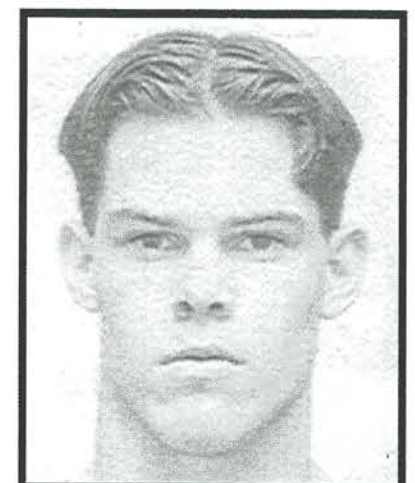

DAVID HARTMAN #60
DAVE IS ATTENDS THE
U.S. NAVAL ACADEMY-
PLAYS ON THE LIGHT
WEIGHT FOOTBALL TEAM



*This page was inadvertently left out of last year's book!
The Printer regrets the Error.*

Congratulations to Neshaminy Redskins 1998 All Stars

Head Coach - Mark Schmidt

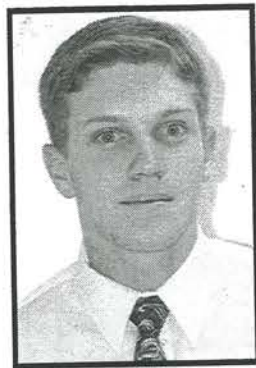

JIM DIETZ



KEVIN MULLINS



FRANK DISANDRO



JIM KELLY

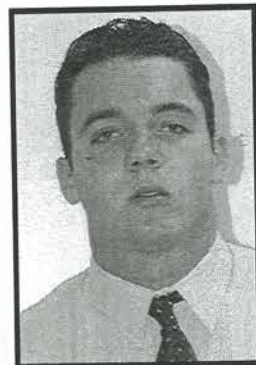

MIKE O'BRIEN



GREG MININGER



JOSH VETTER

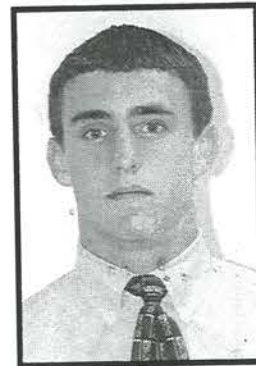

MIKE KELLY



ADAM BEHAR
32

THE "N" CLUB
Neshaminy Football Boosters
P.O. Box 548
Langhorne, PA 19047



JASON JONIGKEIT



1998

CONGRATULATIONS
AND BEST WISHES
TO THESE FINE YOUNG MEN
REPRESENTING
COUNCIL ROCK HIGH SCHOOL

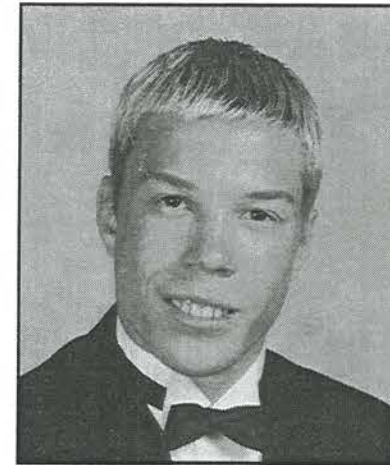

ERIC WARG

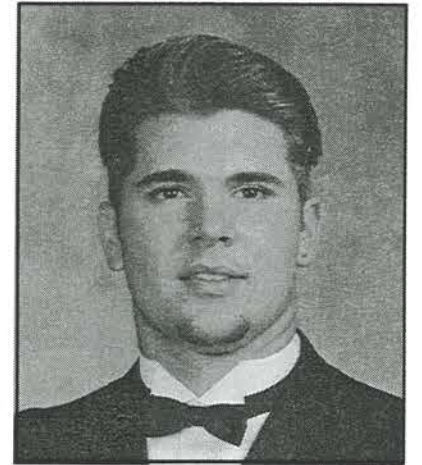

ED JOHNSON

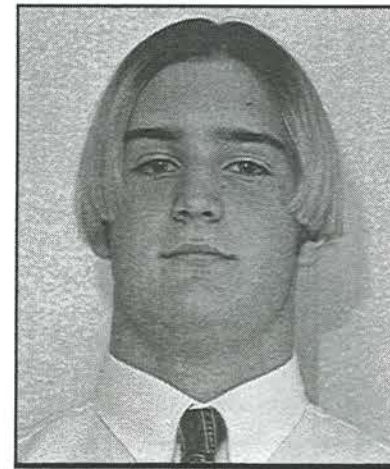

ANDREW WERTZ

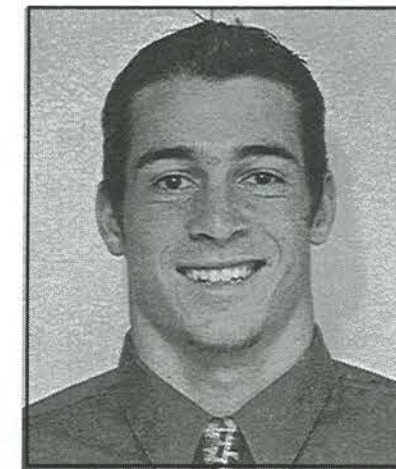

BILL CHIEFFO

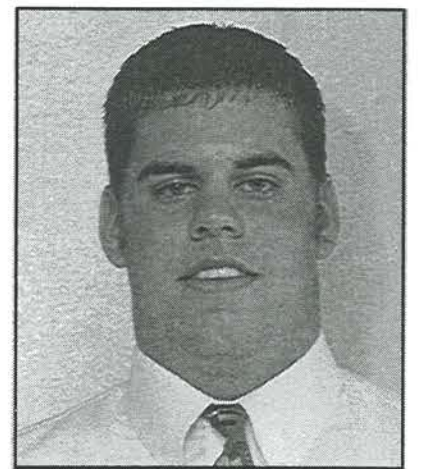

CHRIS YATES

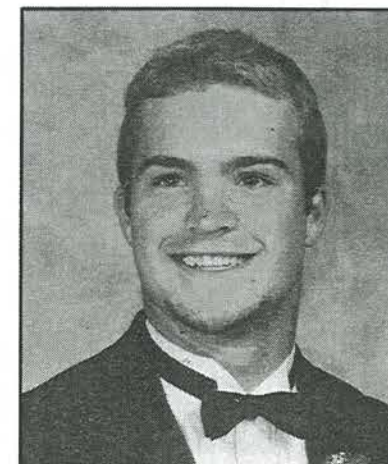

JACK SMITH

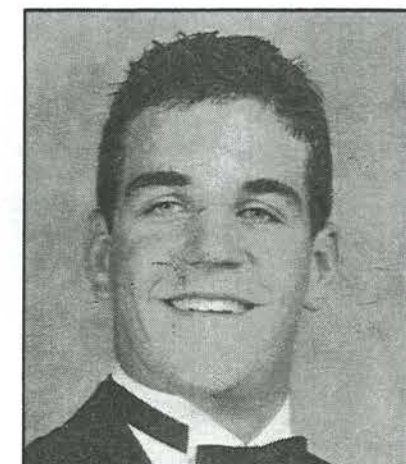

DREW LUDWIG



ARCHBISHOP WOOD CATHOLIC H. S.
PARENTS ASSOCIATION
PROUDLY PRESENTS THE 1998 VIKING ALL-STARS

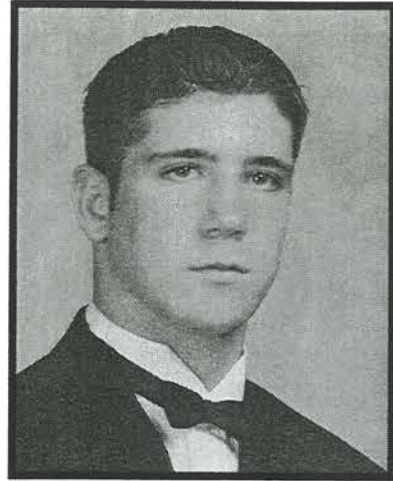

MIKE BECKER

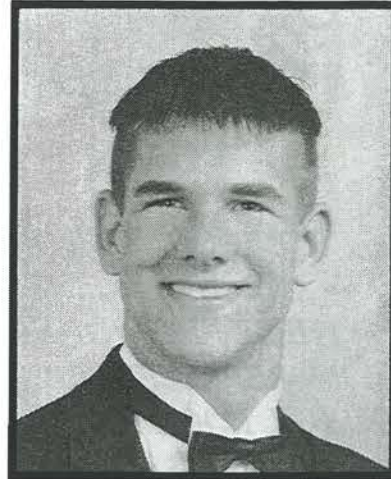

JOHN TRACZYKIWICZ

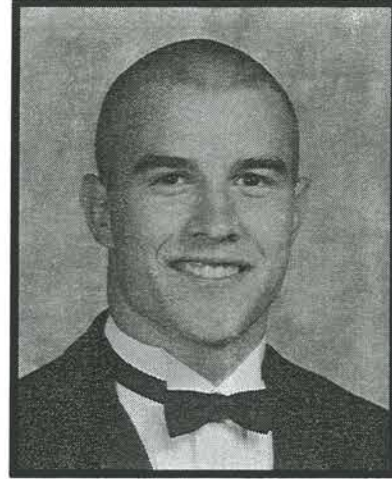

DAN BOYLE

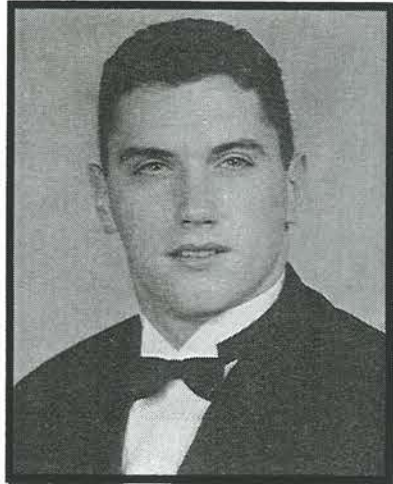

MIKE LACEY

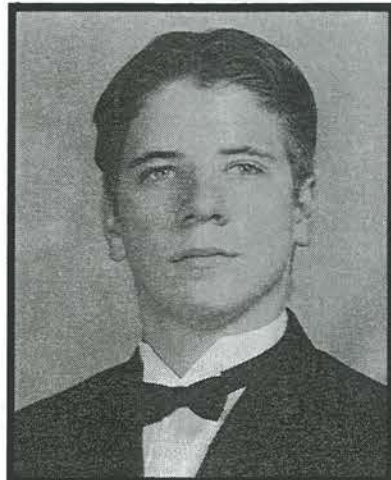

MATT SCHAUB

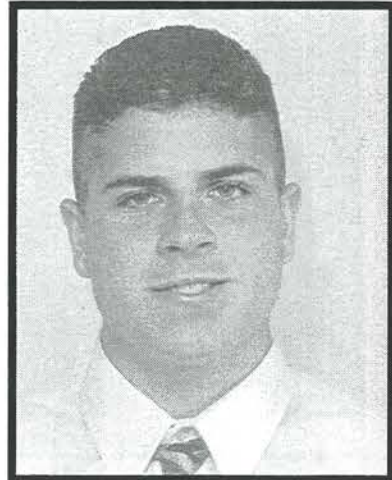

RYAN RUPPRECHT



34 **HEAD COACH: TOM MAGDELINSKAS**



Bensalem Touchdown Club
Congratulations to our 1998
Bensalem High School All Stars
Head Coach: Biz Keeny

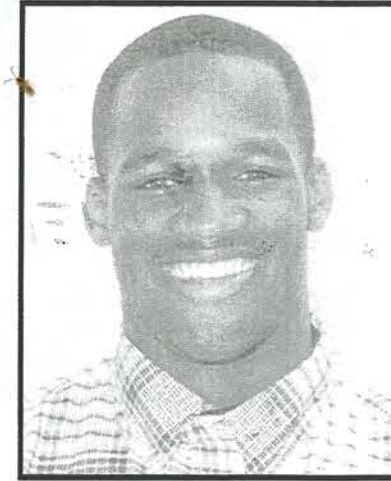

KEITH DAVIS



ROB DUNNER

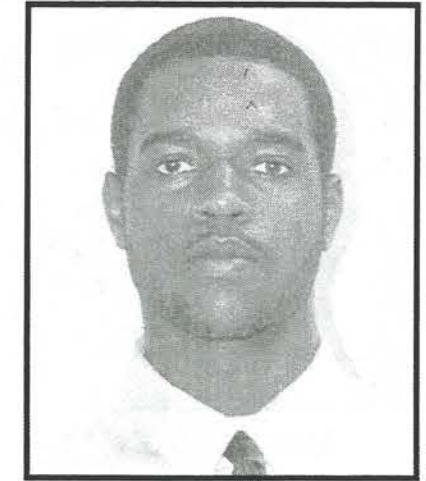

AQUIL FLYTHE

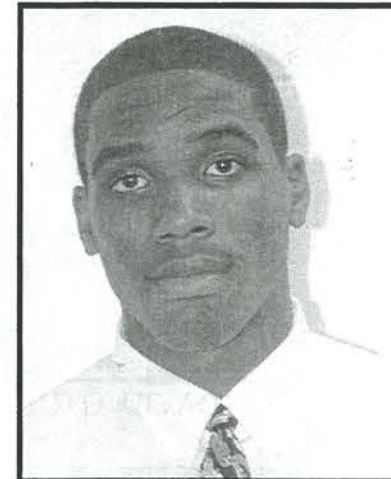

KRISHAN LEWIS

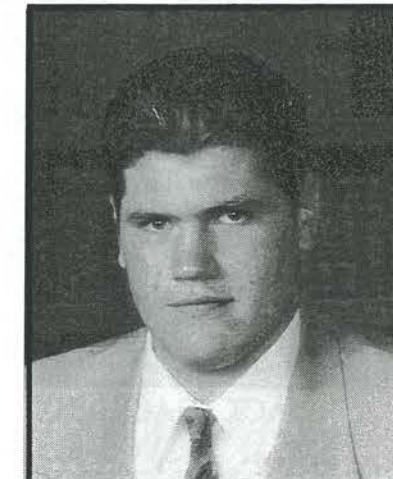

NICK LOMBARDO

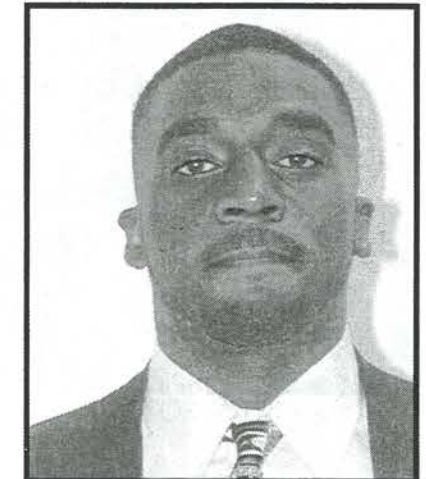

STEVE MASON



RANDY THOMAS



JOHN TUTINO

**P
R
O
U
D

O
W
L
S**

**CENTRAL BUCKS WEST • PIAA CLASS AAAA
PENNSYLVANIA STATE CHAMPIONS 1997
CONGRATULATIONS C.B. WEST ALL STARS**

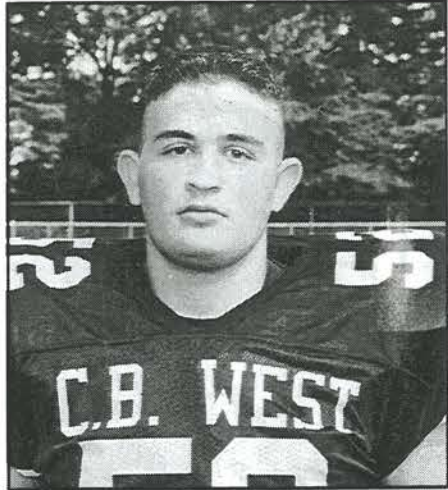

NICK CROGNALE

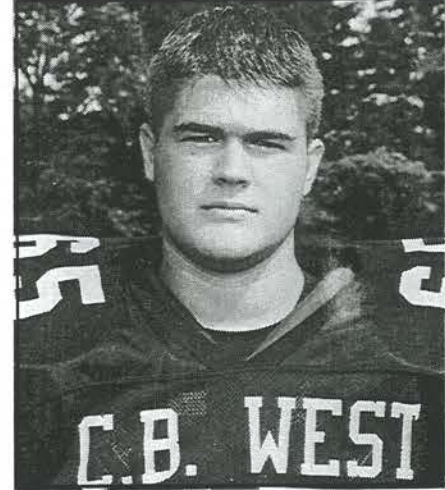

ADAM DOMURAD

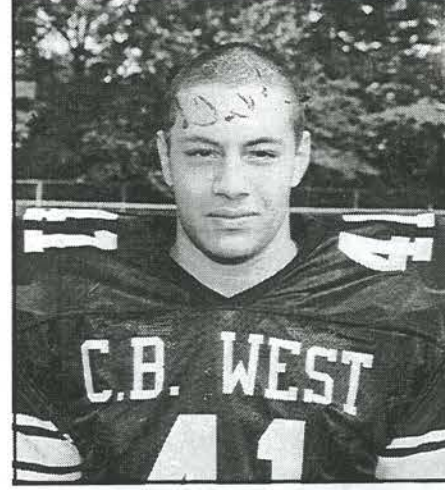

MARIO PALENA

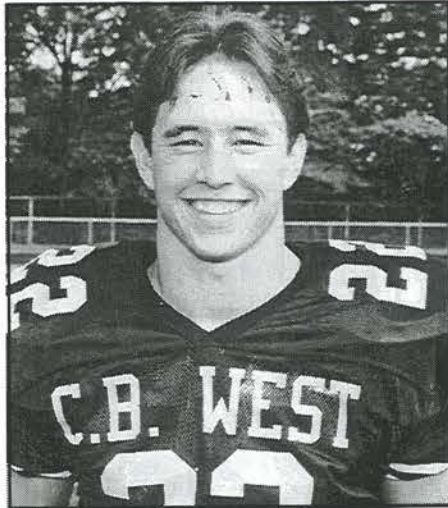

COREY POTTER

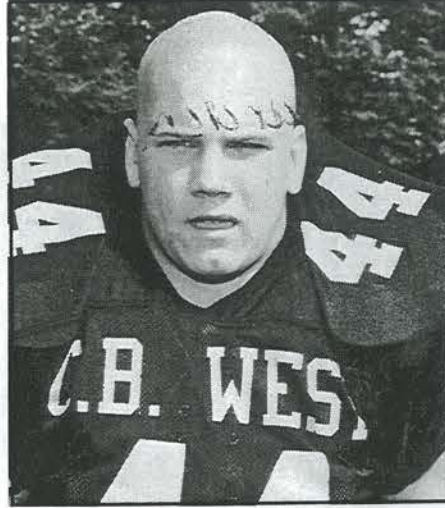

JACK SHACKLETON

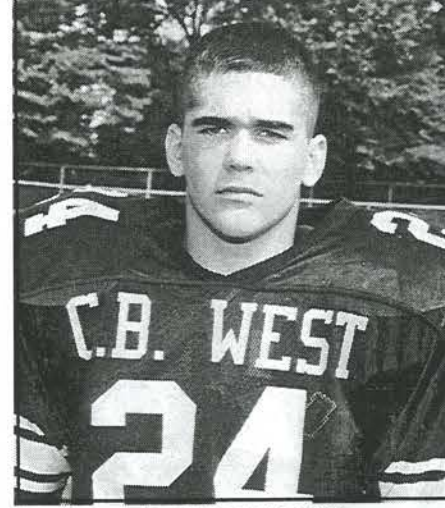

DAVID TITUS

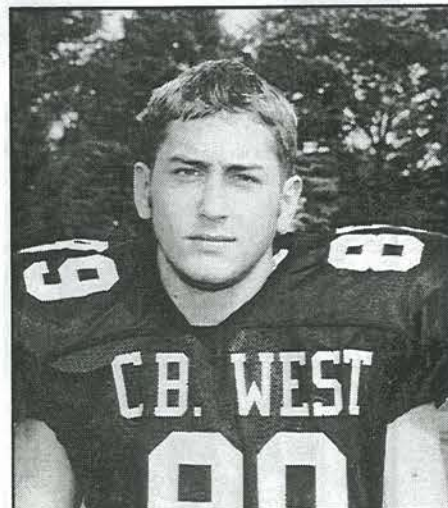

GREG WARD

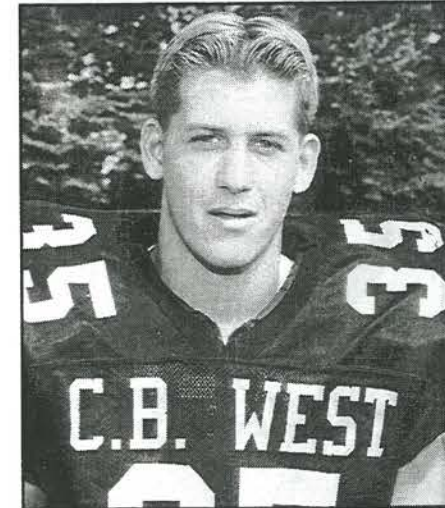

SCOTT WARDEN

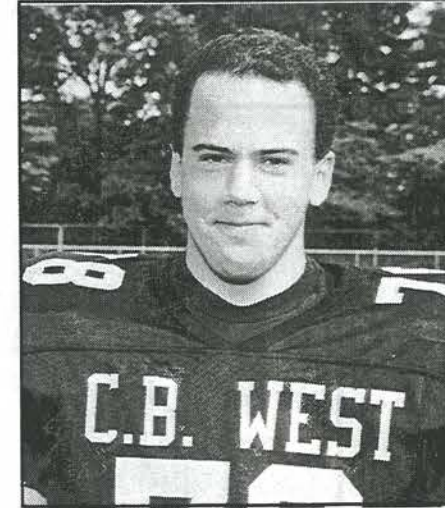

JASON YAICH

**Congratulations and Good Luck
to Both All Star Teams**



**PLUMSTEAD
LIONS CLUB**

President:

Dale Maddux

1997 - 1998

**REGULAR MEMBERSHIP MEETING
SECOND & FOURTH THURSDAY**

at the
PIPERSVILLE INN

*Help the community
come and meet with us*

BRISTOL LIONS CLUB

47 Years of Community Service

1998 presents . . .

26th Annual

Summer Concerts

at the Bristol Lions Park Gazebo
Foot of Mill Street • Bristol, PA 19007

All Concerts Start at 6:00 P.M.

Friday, May 22, 1998
**BRISTOL HIGH SCHOOL
JAZZ AND CONCERT BAND**

Sunday, May 24, 1998
SENTIMENTAL JOURNEY
(rain date - Tues., May 26)

Sunday, May 31, 1998
CRESCENT TEMPLE STRING BAND
(rain date - Tues., June 2)

Sunday, June 7, 1998
MONDAY BLUES BIG BAND
(rain date - Tues., June 9)

Sunday, June 14, 1998
MARIE LANDIS -- BIG BAND
(rain date - Tues., June 16)

Sunday, June 21, 1998
BIG BAND MEMORIES
(rain date - Tues., June 23)

Sunday, June 28, 1998
THE FRANK HERRERA ORCHESTRA
(rain date - Tues., June 30)

Sunday, July 5, 1998
DAISY JUG BAND
(rain date - Tues., July 7)

Sunday, July 12, 1998
DICK CHIMES ORCHESTRA
(rain date - Tues., July 14)

Sunday, July 19, 1998
PUERTO RICAN DAY FESTIVAL
sponsored by Hispanic Association of Bristol Borough
8:00 a.m. to 5:00 p.m.
CONCERT:
6:00 p.m. to 8:00 p.m.

Sunday, July 26, 1998
CELTIC FESTIVAL
sponsored by Celtic Association of Bristol Borough
CONCERT:
6:00 P.M. TO 8:00 P.M.

Sunday, August 2, 1998
THE MOMENTS
(rain date - Tues., August 4)

Sunday, August 9, 1998
AFRO-AMERICAN FESTIVAL
sponsored by Afro-American Association of Bristol Borough
8:30 a.m. to 5:00 p.m.
CONCERT: D.J. CROSSING
Country Western 6:00 p.m. to 8:00 p.m.
(rain date - Tues., August 11)

Sunday, August 16, 1998
CHUCK PENDRAK BANK
(rain date - Tuesday., August 18)

Sunday, August 23, 1998
BRISTOL LIONS ITALIAN FESTIVAL DAY
(rain date - Sun., August 30)
2:00 to 4:00 p.m. - The Joe Scancella Band
5:00 to 7:00 p.m. - Pat Mercury Band

Sunday August 30, 1998
POINT BLANK (40's - 90's Music)
(rain date - Tues., September 1)

Sunday, September 13, 1998
BILL FABRIZIO'S ORCHESTRA
(rain date - Tues., September 15)

1998-1999
Bristol Lions Club

President - Mark Wade
Concert Chairman - Anthony Zanni
Co-Chairman - Anthony Boccardo
Concert Solicitor - Arnand DiRienzo

Meeting Place: Golden Eagle Diner
Route 13 and Bath Road
1st and 3rd Tuesday of each month
6:30 P.M.

For information write:
Bristol Lions
P.O. Box 2161
Bristol, PA 19007



PENNRIDGE-QUAKERTOWN AREA SPORTS HALL OF FAME

Established 1989

MEMBERSHIP

Membership in the Pennridge-Quakertown Area Hall of Fame is open to all sports-minded persons interested in honoring and perpetuating the memory of former athletic ggreats who have brought recongition to the area during thier careers, either through their own achievements or personal influence or contributions.

Dues of \$5 per year are payable t Treasurer George Fox, 1611 park Avenue, Apt. 431, Quakertown, PA 18951. Members may nominate prospective inductees to any officer or board member between November 15 and December 31. Voting by all members who have paid their dues by February 28 is done by mail between March 1 and March 15. New inductees are announced by April 1.

President - Emma Whitney • 536-4150

CONGRATULATIONS

PENNRIDGE

KEITH MOORE
MATT DONOHUE
MIKE BUNTING
FLOYD TURNER
BRIAN MILLER

QUAKERTOWN

JOE EWASHKO
TODD SCHULBERGER
MIKE McGOULDRICK
BRIAN MILLER

everyone's
Talking

We are pleased to support the efforts of the Bob Sands Memorial All Star Football Classic sponsored by the Lions of Bucks County.

"I am a contented customer and a dedicated one. I respect your business, services and the great sales staff."

-G.H.

T

The Thompson Organization
TOYOTA NISSAN LEXUS BMW

1-800-THOMPSON • (1-800-846-6776) • Rts. 313 & 611, Doylestown, PA

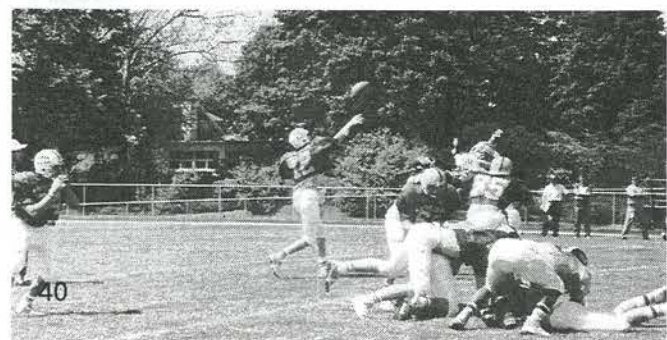
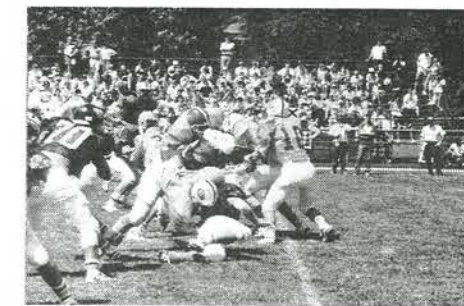
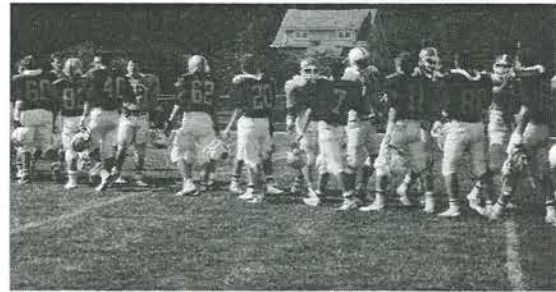
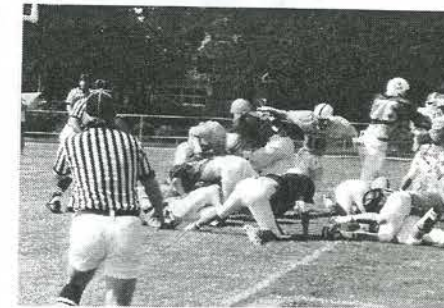
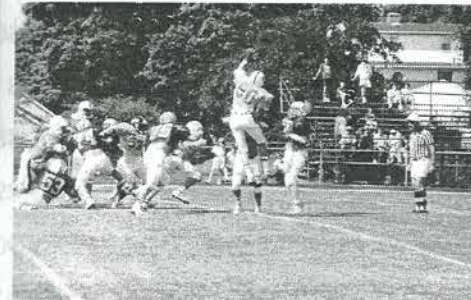
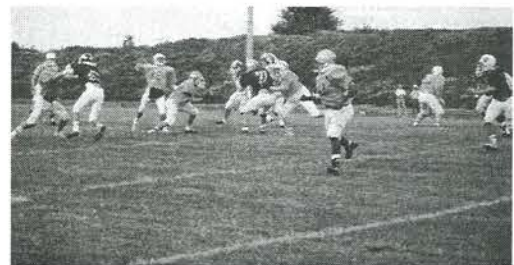
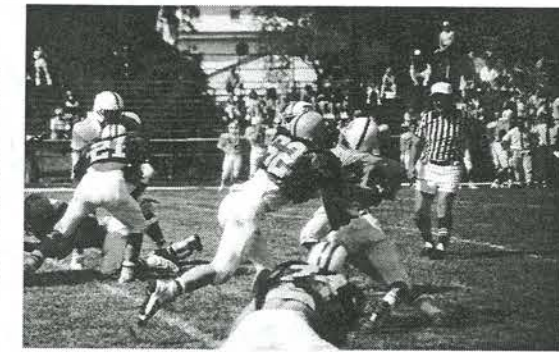
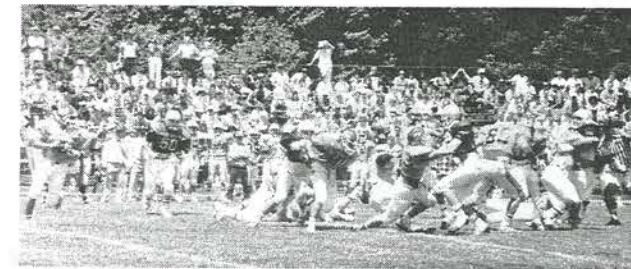
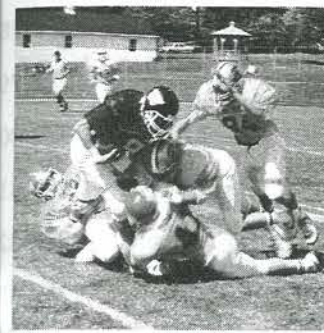
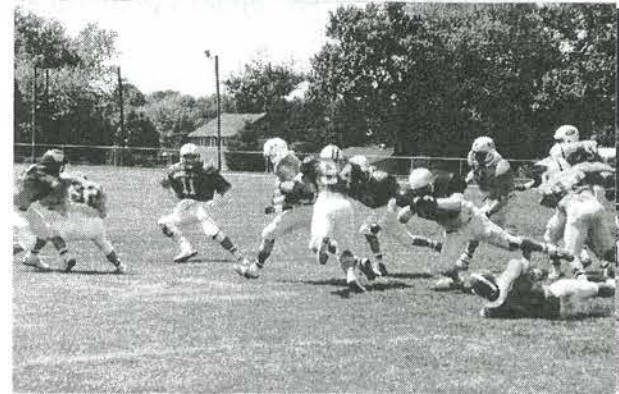
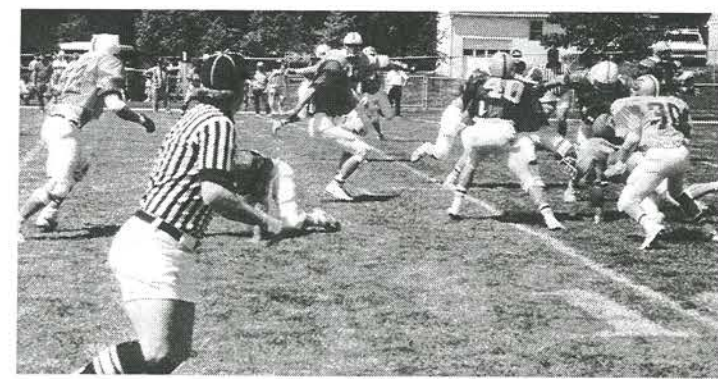
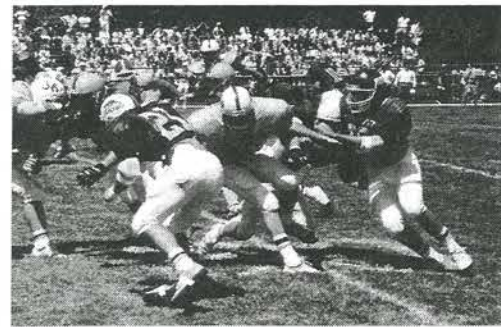



FEASTERVILLE LIONS CLUB

P.O. Box 408 • Feasterville, PA 19053

1997-1998 OFFICERS

Kevin O'Neill
President

Skip Stevens
1st Vice president

Larry Pflieger
2nd Vice President

H. Scott Andrews
Treasurer

Keith Threlfall
Secretary

Board of Directors

Joseph Lennon

Lawrence Pflieger

Joseph Stevens

Robert Fleck, Esq.



We Serve

Best Wishes

to

**All the Stars
on Both Teams
of the**

ALL STAR FOOTBALL CLASSIC

Past President

*Charles MacErlane 1976-77

*Harry Wanner, Jr. 1977-78

Joseph Lennon 1978-79

John Vanyur 1979-80

George Mabrey 1980-81

Robert Oninski 1981-82

George Lewis 1982-83

*Edward Hopkinson 1983-84

*Dr. Bradford Richie 1984-85

Lawrence Pflieger 1985-86

Robert Fleck, Esq. 1986-87

Joseph (Skip) Stevens 1987-88

George Mabrey 1988-89

Howard Scott Andrews 1989-90

David Long, Sr. 1990-91

Kevin O'Neill 1991-92

*Carmen Falsone 1992-93

Don Rubin 1993-94

George Mabrey 1994-95

John Gottschalk 1995-96

Keith Threlfall 1996-97

*Deceased

"IT ALL BEGAN HERE"

"JANUARY 1976"

The First Bucks County All Star Football Committee Meeting



*Standing in Background on Bass - Joe Butera (Tohickon Lions)
Standing in Back Row - Bob Orser (Quakertown), Jack Wilhelm (Richlandtown),
Roger Conduit (Doylestown), George (Mr. Bucks County Rally) Carver (Doylestown)
Sitting - Huck Walton (Levittown), Don "Doc" Sprole (Perkasie),
Bob (Mr. All Star) Sands (Langhorne)
Not In Picture - Jim Kapsak (East Rockhill)*

**GOOD LUCK
NORTH ALL STARS
FROM
TOHICKON LIONS
CLUB
POINT PLEASANT, PA**

MELVIN JONES RECIPIENTS

Bob McKee
Walt Bissonnette
Robert J. Kogut
Samuel E. Turner
Bernie C. Cleary
Frank Weber
David Cayer (Deceased)

LIONS

Scott Nelson
Janet Simmons
Noreen Davenport
Brian Morris
Joseph P. Frotrik



**CHARITABLE
ORGANIZATIONS SUPPORTED**

Bucks County Association for the Blind
Wills Eye Hospital
Penna. Hearing Research
Camp Kirby (Deaf)
Leader Dog for the Blind
Penna. Eye Research
Delaware Valley Eye Bank
L.C.I.F.
Community Projects

**Meets 2nd - 4th Thursday
7 pm
Cock & Bull Restaurant
Lahaska, PA**

OUR 36th YEAR OF SERVICE



**Trumbauersville
Lions
Club**

*Meetings: Spinnerstown Hotel
1st & 3rd Wednesdays*



BUCKS COUNTY LIONS ALL STAR FOOTBALL GAMES



(OFFICIAL RECORD)

Year	Coach	School	North	Coach	School	South
*1972	M. Pettine	CBW	28	C. Kane	Penn. R.	24
*1973	F. Prusch	Q'Town	14	T. Fredrick	Bens.	16
*1974	W. Snyder	CR	0	F. Conger	M'ville	3
*1975	M. Pettine	CBW	36	B. Hart	Bens.	20
1976	B. Juzwiak	Wm. Ten.	45	B. Wagner	BE	13
1977	W. Snyder	CR	14	E. Newman	WW	0
1978	W. Helman	PR	20	B. Hart	Bens.	20
1979	C. Rocconi	CBE	13	B. Travers	BE	13
1980	W. Snyder	CR	27	C. Schmidt	Nesh.	24
1981	D. Peiffer	Q'Town	26	C. Kane	Penns.	13
1982	J. Franchella	Wood	14	T. Magiaracina	Bristol	20
1983	F. Krystyniak	PR	16	J. Ramos	Bens.	14
1984	M. Pettine	CBW	17	W. Snyder	CR	0
1985	D. Shobert	Q'Town	10	M. Ortman	M'ville	7
1986	J. Franchella	Wood	23	H. Johns	H.S.T.	19
1987	M. Collins	Wm. Ten.	12	C. Knowles	B. Egan	13
1988	L. Greene	CBE	35	M. Ortman	M'ville	13
1989	M. Pettine	CBW	14	J. Chaump	Nesh.	15
1990	B. Finley	Wood	20	J. Klebe	Bens.	21
1991	B. Saybolt	Wm. Ten.	21	H. Johns	Tru.	18
1992	M. Ortman	CR	20	J. Cechak	Tru.	12
1993	J. Quinn	CBE	17	L. Greene	Penn. R.	6
1994	B. Hosier	PR	13	R. Dilks	M'ille	6
1995	S. Curley	Q'Town	7	J. Cechak	Tru.	33
1996	M. Pettine	CBW	33	J. Cechak	Tru.	17
1997	T. Magdelinskas	Wood	28	M. Schmidt	Nesh.	28
1998	M. Ortman	CR	?	Biz Keeny	Bens.	?

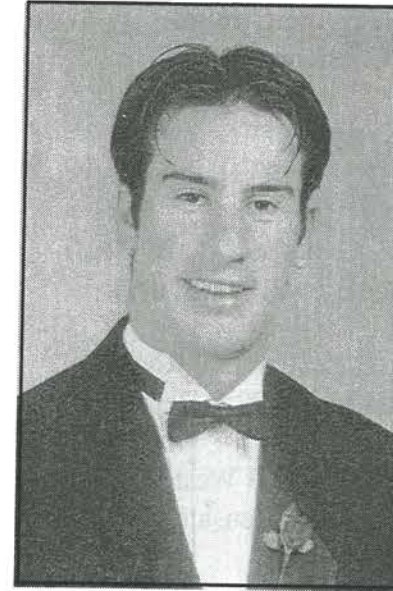

TONY BEVINO

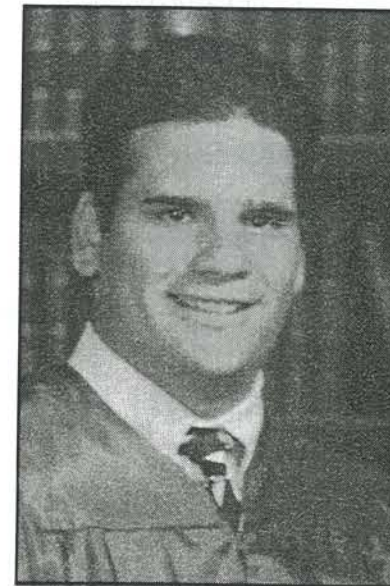

PAUL MARINI



MIKE BENSCOTER



**CENTRAL BUCKS
EAST FOOTBALL
PARENT'S PROGRAM**

Proudly Present's
**OUR CB EAST
ALL STARS**

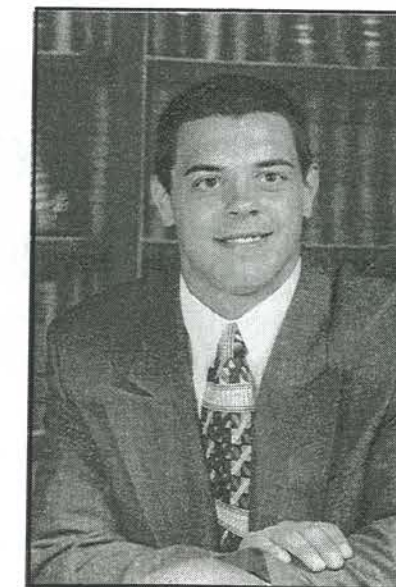

SCOTT TOKA

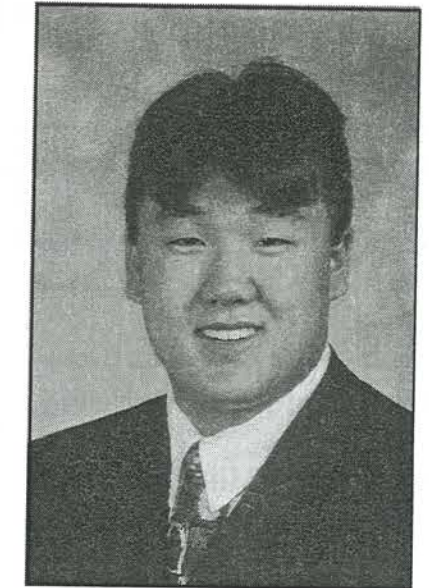

BRIAN SONG

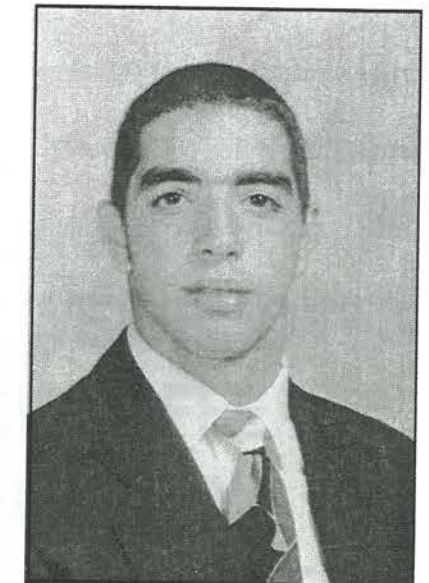

MANNY STOUPAKIS



GAME MVP - SPORTSMANSHIP AWARD

GAME MVP

1993 North - Josh Gallagher (C.B. West)
1993 South - Brian Locke (Bensalem)

1994 North - George Banas (Quakertown)
1994 South - Robsawne Little (Bensalem)

1995 North - Matt Cozza (Council Rock)
1995 South - Kevin Ingram (Harry S. Truman)

1996 North - Mike Erlandson (Council Rock)
1996 South - Tim Smith (Neshaminy)

1997 North - Steve Miller (Pennridge)
1997 South - Todd McLemore (Harry S. Truman)

1998 North - ???
1998 South - ???

GAME SPORTSMENSHIP AWARD

1993 North - Mike Wagner (Archbishop Wood)
1993 South - Jose Contreras (Bristol)

1994 North - Matt Verespy (Archbishop Wood)
1994 South - Glen Braksator (Neshaminy)

1995 North - Randy Overstreet (C.B. West)
1995 South - Jeremy Erlich (Pennsbury)

1996 North - Tony Kurz (Council Rock)
1996 South - Darren Moskovitz (Bensalem)

1997 North - Jim O'Neil (C.B. West)
1997 South - Brian Matto (Bensalem)

1998 North - ???
1998 South - ???

ALL AROUND CHEERLEADER AWARD

1994 North - Kelly Sansouci (Pennridge)

1994 South - Daniele Nester (Morrisville)

1995 North - Christie Heiser (Quakertown)

1995 South - Heather Atkinson (Harry S. Truman)

1996 North - Rian Bales (C.B. West)

1996 South - Baheejan McKinney (Harry S. Truman)

1997 North - Lisa Salvia (Wm. Tennent)

1997 South - Kristen Spadaro (Neshaminy)

MILFORD TOWNSHIP LIONS

WE SERVE



PRESIDENT RON LAUSCH
1st VICE PRESIDENT KENT WEIDEMOYER
2nd VICE PRESIDENT CHUCK GOFFE
3rd VICE PRESIDENT ED ANDERSON
TREASURER MARV REFSNIDER
SECRETARY CHUCK GOFFE



JOSH BURDEN

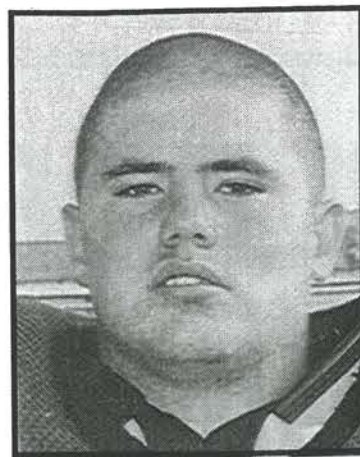

JIM CLAYTON



PAUL COPENHAVER

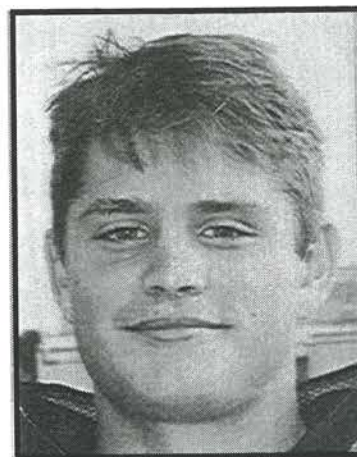

CRAIG LOUGH



BRAD MORGAN

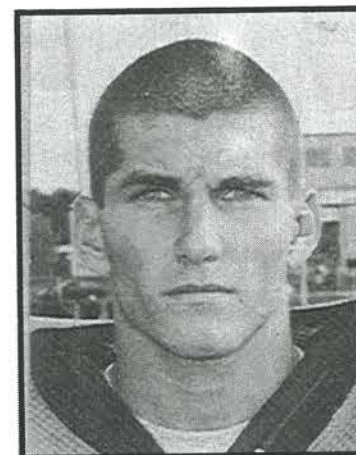

KEITH JOHNSON

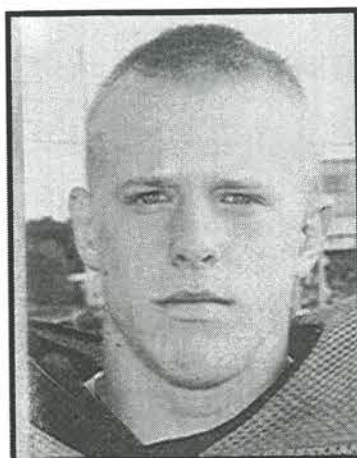

JAMES ROBERTS



DAVID SCHIMPF

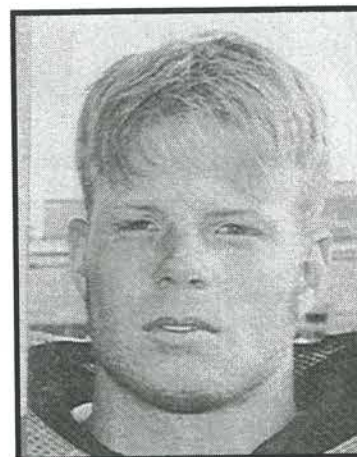

T.J. TIGNOR

HEAD COACH: MIKE ELCO

Congratulations and Good Luck

**to the
1998 Pennsbury Football All Stars
The Pennsbury H.S. Football Parents Club**

SOLEBURY LIONS CLUB

**P.O. BOX 15
SOLEBURY, PA 18963**

**WE SUPPORT
ALL PROJECTS FOR THE BLIND,
DEAF AND COMMUNITY NEEDS.**



**PRESIDENT, LINDA ROWE
SECRETARY, LYNDA FLUITT-CARLIN**



OFFICERS/DIRECTORS

PRESIDENT
Ken Uhl

SECRETARY
Jim Reno

TREASURER
Joseph E. Warner III

1ST VICE PRESIDENT
Estella Kristiniak

2ND VICE PRESIDENT
Herb Drill

3RD VICE PRESIDENT
Karen Crawford

4TH VICE PRESIDENT
Ron Fischer

ONE YEAR DIRECTOR
Larry Hauler
Paul Haupt

TWO YEAR DIRECTOR
Al Santopietro
Joel Krautheim

LION TAMER
Morrell Solly

TAIL TWISTER
Courtney Yelle

MEMBERSHIP CHAIRMAN
Fred Stewart

BULLETIN EDITOR
Herb Drill

"WE ARE PROUD TO SERVE"

**DEDICATED TO COMMUNITY SERVICE
SINCE 1958**

**BEST WISHES TO ALL OF THE ALL-STARS
AND CONFRATLATIONS TO
THE ALL-STAR FOOTBALL COMMITTEE
ON ANOTHER SUCCESSFUL GAME**

REGULAR MEETINGS
1st & 3rd Tuesdays
7:00 p.m.

Jim Breen's Almshouse Inn
59 Almshouse Road
Richboro, PA 18954
(215) 322-3055

FOR FUTHER INFROMATION
PLEASE CONTACT
(215) 355-5259
or
(215) 364-0726

New Members Welcome



CONGRATULATIONS

1998

ALL-STARS

From

Morrisville Lions Club

Serving our Community
for over 40 years



**MEETINGS - 2nd & 4th
Wednesday
7:00 P.M.**

**Picciotti's Catering
100 West Post Road
Morrisville, PA**

CONGRATULATIONS

#8 JERMAINE LIVINGSTON-----WR
#30 BOB ANGELINI-----RB
#72 BRIAN FENNIMORE-----OL

**Presenting A Carnival
August 25th to 29th 1998
Williams park
Morrisville, PA**

President:
Al Christ Jr.

Secretary:
Gunther Berchem

Treasurer:
Karl Haas

GOOD LUCK NORTH-SOUTH ALL STARS



Meeting at 7:00 P.M.
Every Second & Fourth Thursday
**GIUSEPPE'S PIZZA
AND FAMILY RESTAURANT
WARRINGTON, PA**

Warrington Lions



MATT KLINGER #8
Attending Penn State U.
Ogontz Campus



TREVOR ROBINSON #21
Attending Bucks County
Community College

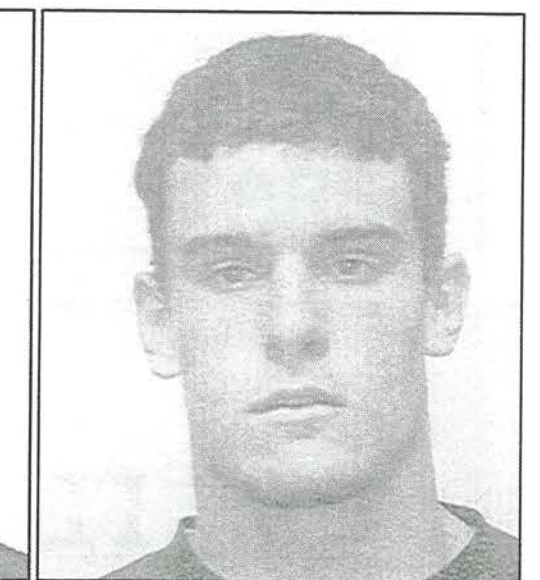

MATT MILONE #70
Attends U. of New Haven. Will
Play Offensive Tackle Next Year



KEVIN KARPUK #72
Attending Lehigh U.

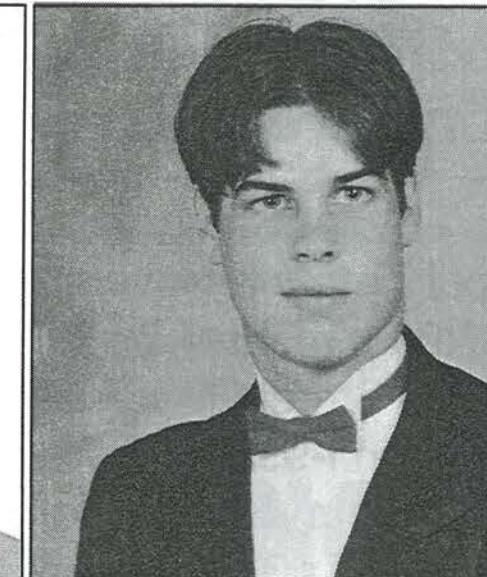

CHRIS MONTAGINO #5
Attending U. of Indiana (PA)

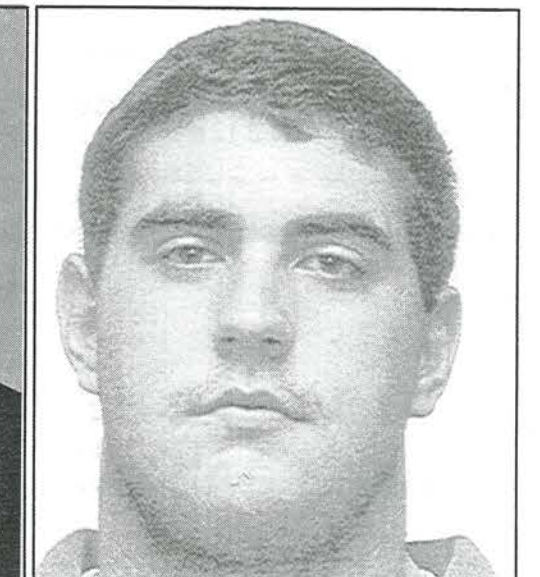

JEFF GROSS #82
Attends Shippensburg
and Playing Tackle

This Page was inadvertently Credited to the Wrong School Last Year



*Congratulations and Best Wishes
To These Fine Young Men Who Represented Council Rock High School*

Good Luck to the Bensalem All-Stars



Bensalem Lions Club
FLEA MARKET

at
Neil Armstrong
Middle School
on Street Road

Every Saturday
April Through November
7:00 a.m. until 2:p.m.
Street Road
between I-95 and Route 1
Bensalem, Pennsylvania
Information call 633-3655 Ext #. 3000

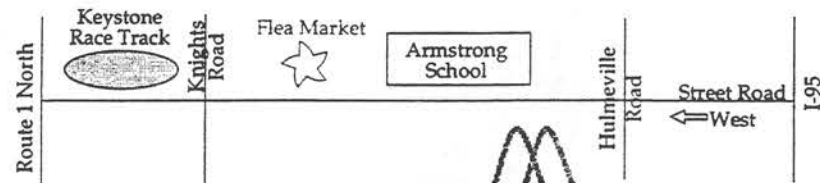

100 Outdoor Spaces
Food Concession
Ample Free Off-Road Parking
Clean Lot

President - Bill Childress
Secretary - Ken Buckalew
Treasurer - Ken Buckalew

**CONGRATULATIONS TO
THE BUCKS COUNTY ALL-STARS**



FROM THE OTTSVILLE LIONS CLUB
"WE ARE PROUD TO SERVE"

VIVIAN BEYON - PRESIDENT
KATHY GERONI - SECRETARY

CHARTERED 1991

**WINGATE
SANDBLASTING**

215-249-3517
800-585-0043

• Pools • Buildings • Equipment • Wood
• Residential • Commercial • Industrial

P.O. Box 470
Doylestown, PA 18901

DON WINGATE
PROPRIETOR

1998 ALL-STAR COMMITTEE PRESENTS

PRE-GAME

WELCOMING ADDRESS
INTRODUCTION OF THE COLOR GUARD
INTRODUCTION OF DISTRICT GOVERNORS OF 14-A
INTRODUCTION OF LIONS CLUB BANNERS
INTRODUCTION OF CHEERLEADERS (NORTH)
INTRODUCTION OF CHEERLEADERS (SOUTH)
INTRODUCTION OF PLAYERS AND COACHES (NORTH)
INTRODUCTION OF PLAYERS AND COACHES (SOUTH)
INTRODUCTION OF GAME OFFICIALS
NATIONAL ANTHEM

HALF TIME SHOW

AWARD WINNING COUNCIL ROCK MARCHING BAND
DANCE ROUTINE BY THE CHEERLEADERS FROM
THE NORTH (COUNCIL ROCK H.S.) AND THE SOUTH (BENSALEM H.S.)
FIELD GOAL KICKING CONTEST - PRIZES!

24 Hour
emergency service

HVAC

DIVERSIFIED REFRIGERATION INCORPORATED

105 HIGH STREET, DUBLIN, PA 18917
(215) 249-0445
1-800-938-COOL

Refrigeration • Air Conditioning • Duct Work
Design and Installaation • Environmental Cham-
bers • Ice-machines M.R.I. • Certified Aerco Boiler
Service • Air-dryer Service and Repair.

PLANNED PREVENTIVE MAINTENANCE
24-HOUR EMERGENCY SERVICE
1-800-938-COOL



HARRIS BROS. BUICK OLDS

Quakertown Plaza • Route 309 • Quakertown, PA 18951
MAILING ADDRESS: 49 N. West End Blvd.

Merthyn R. Harris

(215) 538-1100

Fax (215) 538-7377

deGROUCHY, SIFER & COMPANY

CERTIFIED PUBLIC ACCOUNTANTS

WILLIAM J. SIFER CPA
PARTNER

892 SECOND STREET PIKE

RICHBORO, PENNA. 18954

(215) 322-4055

CONGRATULATIONS

to

BUCKS COUNTY ALL STARS

Good Luck Bucks County All-Stars!

COMMUNICATION CONCEPTS INC.

A member of the Communication Concepts Group

providing
"Award Winning" service
to direct marketers
from concept to conclusion!

- Database Creation and Maintenance
- Data Enhancement
- Laser Personalization
- Custom Mailing and Fulfillment Programs

COMMUNICATION
CONCEPTS INC.
A member of the Communication Concepts Group

1044 Pulinski Road
Ivyland, PA 18974
(215) 672-6900
Internet: www.ccgrouppnet.com

Financial solutions for the way you live today

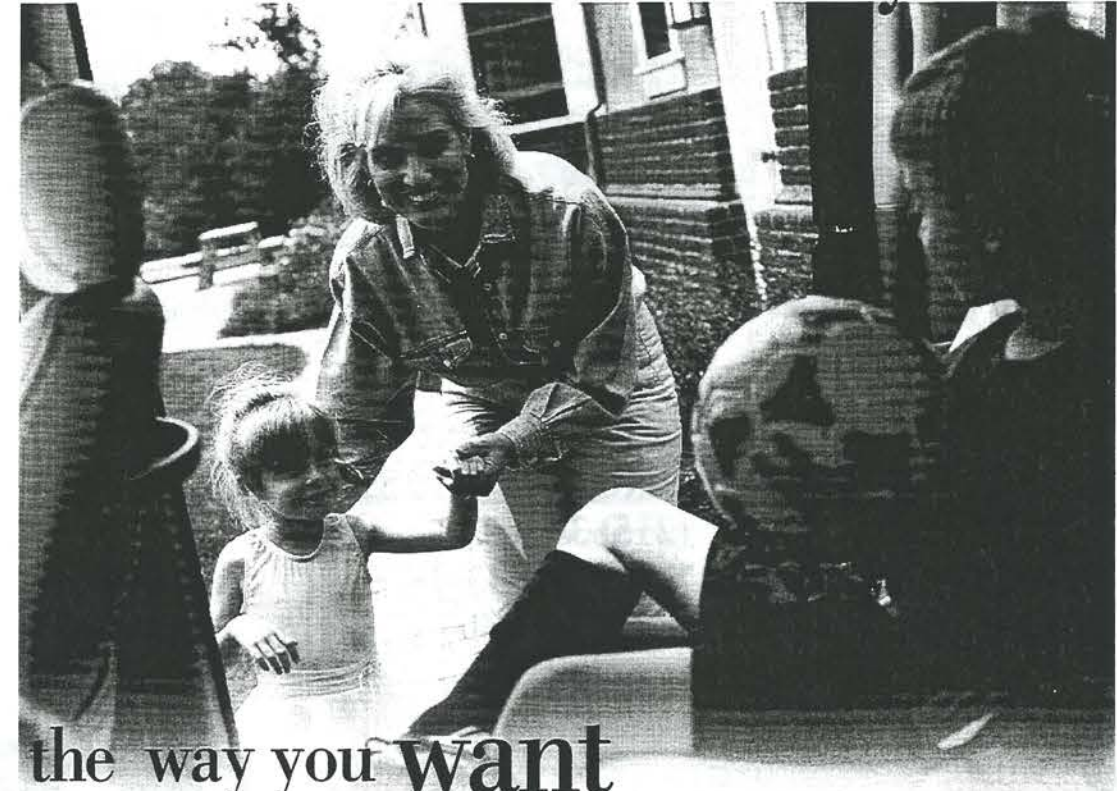

and the way you want
to live tomorrow.

Soccer practice, ballet lessons and the veterinarian. And no time to think about planning for tomorrow. Getting through today is tough enough.

At Keystone Bank, we make financial planning for tomorrow easy. With our Relationship Banking packages like KeySourceSM, you'll get banking convenience today with the planning that is essential for tomorrow. Stop into your local Keystone Bank office and talk to a Relationship Banker. Because your tomorrows are just as important as your todays!

Keystone
Bank 

A Keystone Financial Community Bank

Newtown office: So. State & Chancellor Sts. Phone 860-4010
Southampton office: 1111 Street Road Phone 322-1965

Member FDIC

Carroll Engineering Corporation

SUITE 3
219 MAIN STREET
TRAPPE, PA 19426
(610) 489-5100
FAX: (610) 489-2674



901 WOODBINE AVENUE
BENSALEM, PA 19020
(215) 638-3400

• MAIN OFFICE •

949 EASTON ROAD, SUITE 100
WARRINGTON, PA 18976
(215) 343-5700

FAX: (215) 343-0875

EMAIL: cecmail@carrollengineering.com

*Offering a wide range of
Engineering Services, including;*

Municipal

Authority

Environmental

Traffic

Recreational

Structural

GIS

Celebrating our 25th Anniversary!

andersen engineering associates, inc.

engineering ▲ environmental studies ▲ subdivisions ▲ surveying ▲ water & sewer design

306 n. fifth st. 2nd floor ▲ perkasio, pa. 18944
phone: 215/257-5711 ▲ e-mail: aeapca@prodigy.net ▲ fax: 215/257-5766

president: peter c. andersen, p.e.

Engineering

Land Development

▲ Planning ▲ Zoning Review ▲ Approvals ▲ Permits ▲ Project Management ▲ Construction Management ▲

Storm Water Management

▲ Dam Design ▲ Storm Drainage Systems ▲ Sedimentation, Water Quality & Detention Basins ▲
▲ Flood Control Measures▲

Water and Wastewater

▲ Sewage Collection, Treatment & Disposal Facilities ▲
▲ Water Supply, Treatment, Pumping, Distribution & Storage Facilities ▲

Surveying

▲ Title Surveys ▲ Topographical Surveys ▲ Computer Calculation Services ▲ Geodetic Surveys ▲
▲ Construction Control ▲ Cadastral Surveys ▲ Subsurface Utility Engineering ▲
▲ Easements ▲ Wetlands Location ▲

Planning

▲ Conceptual ▲ Layout ▲ Permit Assistance ▲ Site Renderings ▲ Expert Testimony ▲

COLDWELL BANKER HEARTHSIDE-WASHINGTON CROSSING
(215)493-1877



(215) 493-1877 EXT. 123 BUSINESS
(215) 493-6580 FAX
(215) 245-1337 RESIDENCE
MARTY LOMBARDO, CCPS, CRRS
REALTOR®

COLDWELL BANKER
COLDWELL BANKER HEARTHSIDE, REALTORS®
1118 GENERAL WASHINGTON BLVD.
WASHINGTON CROSSING, PA 18977

An Independently Owned and Operated Member of Coldwell Banker Real Estate Corporation



(215) 493-1877 BUSINESS EXT 125
(215) 493-6580 FAX
(215) 968-5939 RESIDENCE

GALE OWENS, GRI
REALTOR-ASSOCIATE®
Certified Relocation Specialist

COLDWELL BANKER HEARTHSIDE, REALTORS®
RESIDENTIAL REAL ESTATE
1118 GENERAL WASHINGTON BLVD
WASHINGTON CROSSING, PA 18977



An Independently Owned and Operated Member of Coldwell Banker Residential Affiliates, Inc.



(215) 493-1877 BUSINESS
(215) 493-6580 FAX
(215) 322-1929 RESIDENCE

TIBBY WATSON
REALTORS®
Over 12 Years Experience

COLDWELL BANKER
COLDWELL BANKER HEARTHSIDE, REALTORS®
1118 GENERAL WASHINGTON BLVD
WASHINGTON CROSSING, PA 18977

An Independently Owned and Operated Member of Coldwell Banker Residential Affiliates, Inc.



(215) 493-1877, EXT. 119 BUSINESS
(215) 493-6580 FAX
(215) 321-3994 RESIDENCE

NANCY MARTIN
REALTOR®

COLDWELL BANKER HEARTHSIDE, REALTORS®
1118 GENERAL WASHINGTON BLVD.
WASHINGTON CROSSING, PA 18977

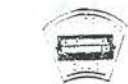

An Independently Owned and Operated Member of Coldwell Banker Residential Affiliates, Inc.

(215) 493-1877 BUSINESS, 141 VM
(215) 493-6580 FAX
(215) 396-0103 RESIDENCE

MARY KONONENKO

COLDWELL BANKER HEARTHSIDE, REALTORS®
1118 GENERAL WASHINGTON BLVD.
WASHINGTON CROSSING, PA 18977

An Independently Owned and Operated Member of Coldwell Banker Real Estate Corporation



(215) 493-1877 EXT. 116 BUSINESS
(215) 493-6580 FAX
(215) 860-9566 RESIDENCE

JIM SEIBERT
REALTOR-ASSOCIATE®

COLDWELL BANKER HEARTHSIDE, REALTORS®
RESIDENTIAL REAL ESTATE
1118 GENERAL WASHINGTON BLVD.
WASHINGTON CROSSING, PA 18977



An Independently Owned and Operated Member of Coldwell Banker Residential Affiliates, Inc.

(215) 493-1877 BUSINESS, 147 VM
(215) 598-8016 HOME

JEROME SCHLANGER

COLDWELL BANKER HEARTHSIDE, REALTORS®
1118 GENERAL WASHINGTON BLVD.
WASHINGTON CROSSING, PA 18977

An Independently Owned and Operated Member of Coldwell Banker Real Estate Corporation



(215) 493-1877 BUSINESS
(215) 493-6580 FAX
(215) 493-5415 RESIDENCE

JOHN F. KENNEDY
REALTOR®
PAR Excellence Club

COLDWELL BANKER HEARTHSIDE, REALTORS®
1118 GENERAL WASHINGTON BLVD.
WASHINGTON CROSSING, PA 18977



An Independently Owned and Operated Member of Coldwell Banker Real Estate Corporation

Call Coldwell Banker.

ROBERT B. WRIGHT, REALTOR, CRMS

I COVER BUCKS COUNTY-CALL ME AT (215) 493-1877 EXT 117

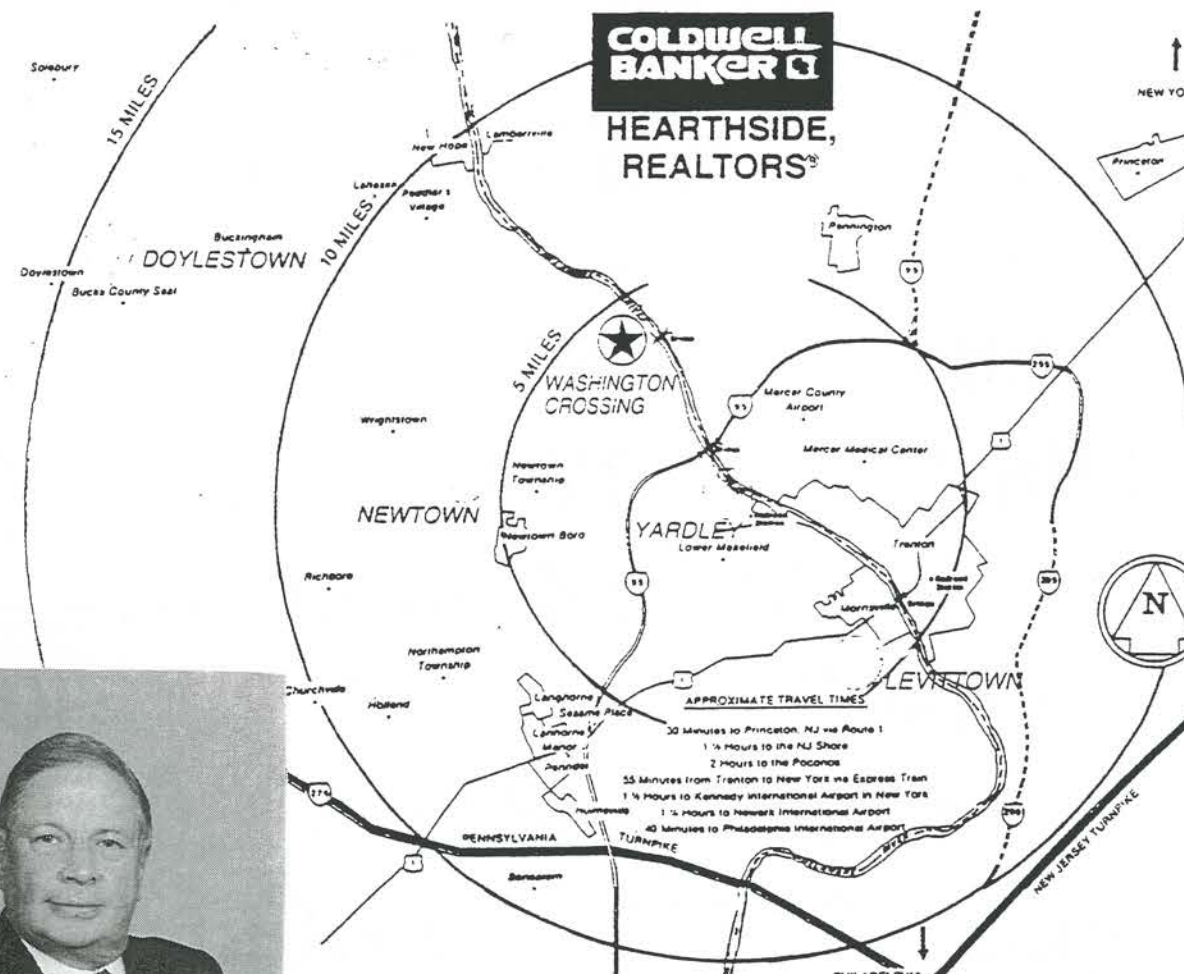

★ OFFICE LOCATION **RELOCATION SPECIALIST**
BUYER BROKER SPECIALIST
RETIRED IBM EXECUTIVE

MAKING REAL ESTATE REAL EASY.™

©1997 Coldwell Banker Real Estate Corporation. An Equal Opportunity Company. Equal Housing Opportunity. All offices independently owned and operated. In Canada, each office is an independently owned and operated member broker of Coldwell Banker Affiliates of Canada.

www.coldwellbanker.com



An Independently Owned and Operated Member of Coldwell Banker Real Estate Corporation

CAN DO COMPUTER SERVICES

CUSTOM TOP QUALITY PC'S
HIGH PERFORMANCE LAPTOPS
OFFICE NETWORKING
PERSONALIZED INSTRUCTION
PC TROUBLESHOOTING
PREPURCHASE CONSULTATION

CAN DO CONSULTANTS, INC.
(215) 997-7683 OFFICE
(215) 997-1625 FAX

We salute the Lions and Players who have chosen to express their competitive energies in such positive and supportive sports as this All Star Football Classic:—



The Citizens Crime Commission of Bucks County

The Citizens Crime Commission of Bucks County is a private, voluntary, non-profit organization of business and professional firms and concerned citizens dedicated to

- *improving the criminal and juvenile justice systems;*
- *diminishing the causes of criminal activity and stimulating public interest therein;*
- *aiding law enforcement agencies in the proper discharge of their duties; and*
- *participating in efforts to prevent crime and delinquency.*

Realizing that crime, drugs and violence, and the measures we have taken to deal with them, have cost over half a Trillion Dollars every year, not counting the personal loss in lives and broken families, we know that we cannot escape either the responsibility or the opportunity of becoming personally involved; and of becoming not merely angry, but effective! You, your family and your firm are invited to join with us.

For information, call the Lower Bucks County Chamber of Commerce, (215) 943-7400, and speak to Lion George Oppenheimer, Jr., Executive Director of the Citizens Crime Commission of Bucks County, or write the Commission: P. O. Box C, Yardley, PA 19067-8120.

Please watch your local cable channels for replays and followup broadcasts of programs sponsored by the Citizens Crime Commission focusing on violence in the workplace, the schools, the home and on the streets, and watch for copies of the "Danger Quotient Quiz" through which you can express your own perception of the problem and its solutions!

*Support the creation and growth of Leo Clubs
and the Lions Youth Outreach Programs
to create a healthy community with
positive values for our youth!*

**GOOD LUCK
TO
BUCKS COUNTY ALL-STARS**

Compliments of



Jack Fox, President

Snyder's

Feels Like Home!

Family Owned & Operated Since 1884
Estate of GEO. S. SNYDER, Inc.
1700 Hatfield Valley Road, Hatfield PA
215-855-2131 FAX 215-855-8485
E-Mail: snyders@snyders.com



**SUBARU OUTBACK[®]
THE WORLD'S FIRST
SPORT-UTILITY WAGON**



The Beauty of All-Wheel Drive[®]
801 Bethlehem Pike, Sellersville
(215) 257-8022 1-800-282-4389

FARM & HOME

OIL COMPANY

3115 State Road, Telford
257-0131

Your Community Dairy

Rosenberger's
DAIRIES
SINCE 1925

Quality Dairy Products

855-9074

EARL-BOWL LANES
PRO SHOP

Bowling Balls - Bags - Shoes

251 WEST END BLVD.
QUAKERTOWN, PA
Phone 215-536-7199

390 MORWOOD ROAD
EARLINGTON, PA
Phone 215-723-9130

BIRTHDAY PARTIES
BUMPER BOWLING



BERGEY'S JEEP EAGLE
1301 N. Broad St.
LANSDALE, PA 19446



There's Only One Jeep.

Grand Cherokee Wrangler Cherokee Avenger Talon



Bus. Phone (215) 855-3107

Mobil
Convenience Store

(215) 723-9941
(215) 723-7776

COUNTY LINE SERVICE CENTER

Route 113 & County Line Road
Souderton, Pennsylvania 18964

Complete Car Service
State Inspection

EARL SMITH

Routes 113 & 309 • Souderton, PA 18964



This coupon entitles the bearer to one soft
cloth car wash as indicated

No. 3720

SOUDERTON
Starwash
Starbrite
Starburst ←

**KEYSER
MILLER**
Ford

3470 Bethlehem Pike
Souderton, PA. 18964
(215) 723-9894

Cars---Trucks---Parts---Service



Symbol of Outstanding
Service

Indian Valley Camping Center, Inc.
ROUTE 309 & COUNTY LINE ROAD
SOUDERTON, M. R. 1, PA. 18964

PHONE 723-4852
AREA CODE 215

Office Hours By Appointment

JEFFREY R. BRENNER, D.M.D.
Family Dentistry

769 Second Street Pike
Southampton, Pennsylvania 18966
Telephone: (215) 357-9199
Fax: (215) 357-8049

50% OFF LUNCH OR DINNER

Present this coupon and receive 50% Off a Lunch or Dinner entree when a second entree of equal or greater value is purchased.

- Visit Our Famous Salad Bar
- Try Our Fresh Homemade Soups

Please present coupon
When seated • Expires 12-31-98

Generations
at the Warrington

Route 611, north of Street Road, Warrington 343-5600



BEEF PACKERS • RENDERERS

Moyer Packing Company

P.O. BOX 395 • SOUDERTON, PA 18964-0395 • (215) 723-5555

PISCITELLI ASSOCIATES
ACCOUNTING AND TAX SERVICES

1017 Bellevue Avenue
Langhorne, PA 19047

Represented by:

Lion Clem Piscitelli
(Langhorne Lions)

Tel: (215) 757-2943
Fax: (215) 741-4503

**Community
Banking**
at its Best!



UNIVEST

Union National Bank • Pennview Savings Bank

Members FDIC

Traction by Design™

The Green Keepers Difference.

"Since I started wearing Green Keepers, I have had tremendous success on the Senior PGA Tour. No other alternative spike has offered me the sure-footed traction that Green Keepers do. Green Keepers have become the spike of choice for me."
- Hale Irwin

Self-Locking Threads

Ribbed thread design assures cleat stays tight

Outward-Angled Traction Teeth

Provide lateral Traction

Hale Irwin

Perfect Fit

Precision ground thread sizes provide easy installation and won't crossthread

Anti-Debris Ring

Reduces debris build-up between shoe sole and cleat

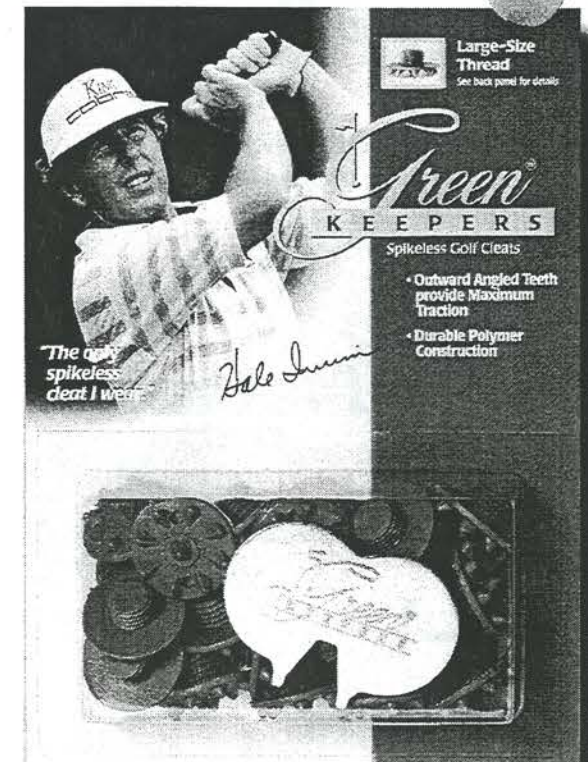
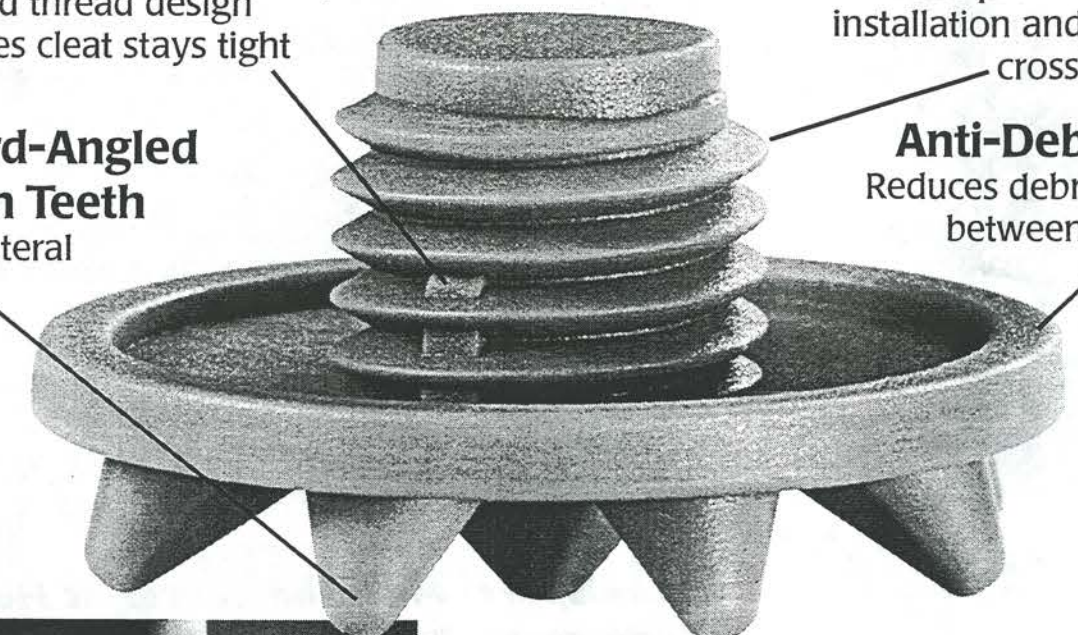

db1506/9 150 Count Display Bowl
db5006/9 500 Count Display Bowl
db2506/9 250 Count Display Bowl
Bulk quantities are also available.



Green
KEEPERS

2180 Bennett Road, Phila. PA 19116

1-800-317-2663

www.gkspikes.com

Get Back in the Thick of It.

Don't let an injury put you on the sidelines this season. Whether you're in team sports or a solo walker, we'll help you recover from an injury and get back to enjoying your sport.

Our exceptionally trained sports medicine specialists will evaluate and help you rehabilitate in our outstanding facilities which include physical therapy, aquatic therapy, sports medicine and industrial rehabilitation.

Whether you're a high school athlete, an aerobics enthusiast, or a weekend warrior, don't miss out on the best season.

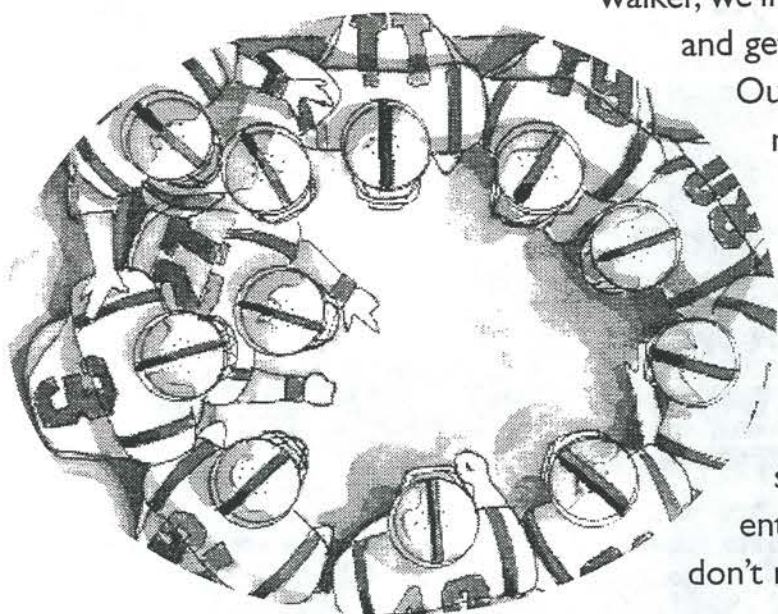

Call the **Sports Medicine Center at Holy Redeemer** at **215-938-1500** for total care from any sports injury.

Dr. Robert Mannherz, Medical Director of Sports Medicine at Holy Redeemer, is the orthopedic consultant for Academy of the New Church, Holy Ghost Preparatory, Lower Moreland High School and William Tennent High School.



1648 Huntingdon Pike • Meadowbrook, PA 19046
173 Jacksonville Road • Ivyland, PA 18974

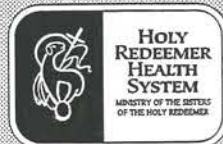

Holy Redeemer
A System of Caring

BCM

Begley Carlin & Mandio

750-0110

680 Middletown Boulevard
Langhorne, PA

788-0471

120 Mill Street
Bristol, PA

Serving Bucks County Since 1933

PERSONAL INJURY

- AUTO ACCIDENTS
- MEDICAL MALPRACTICE
- DEFECTIVE PRODUCT CLAIMS
- TOXIC WASTE INJURIES
- WORKERS COMPENSATION

FAMILY LAW

- DIVORCE
- SUPPORT
- CUSTODY

ESTATES & WILLS

- POWERS OF ATTORNEY
- LIVING TRUSTS

BUSINESS LAW

- INCORPORATIONS
- PARTNERSHIPS
- BUSINESS BANKRUPTCIES

REAL ESTATE LAW

- RESIDENTIAL & COMMERCIAL
- ZONING & LAND DEVELOPMENT
- TITLE INSURANCE
- REAL ESTATE SETTLEMENTS

CRIMINAL LAW

- DRUNK DRIVING
- FELONIES & MISDEMEANORS



HARLEYSVILLE NATIONAL

Bank and Trust Company

MEMBER FDIC

Featuring products for the whole family!

- Checking / Savings Accounts
- H.A.L. - Our Telephone Banking Service
- Kids Banking
- Savings Plans
- IRAs / CDs
- Mortgages / Home Equity Loans

To catch the details about these services and our other offerings—

Call
1-888-HNB-2100

or stop in any of locations
throughout Montgomery, Bucks and Chester Counties,
"Where everyone is an All-Star."



Proud to support Bucks County Lions Club

Law Offices of
C. MICHAEL KOELZER
PERSONAL INJURY LITIGATION

FELA/RAILROAD INJURIES

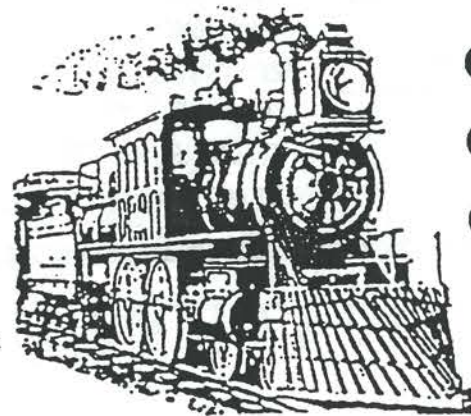

- AUTO ACCIDENTS
- DEFECTIVE PRODUCTS
- MEDICAL MALPRACTICE
- SLIP & FALL

GENERAL PRACTICE INCLUDING:

- DRIVING OFFENCES ● CRIMINAL LAW
- WILLS ● FAMILY LAW

348-1834

44 E. COURT ST. DOYLESTOWN, PA. 18901

PATRONS

ALL STAR COMMITTEE

- Frank Kolanko (Southampton)
- Marie Kolanko (Southampton)
- Sam Costantini (Southampton)
- Faith Costantini (Southampton)
- Gloria Suppin (Southampton)
- Walter Bitterlich (Northampton)
- Joe Warner (Northampton)
- Mary Santopietro (Northampton)
- Gary Hirthler (Softball-Golf)
- Gunther Berchem (Morrisville)
- Samuel Turner (Tohickon)
- Bill Redstreak (Southampton)
- James Kapsak (East Rockhill)
- Denny Krause (East Rockhill)
- Ron Buckley (East Rockhill)
- John Britsch (East Rockhill)
- Gene Kennedy (Newtown)
- Nickolas Decker (Hilltown)
- Oliver Wilson (Doylestown)
- Don Werner (Perkasie)
- Jim Davis (Chalfont)
- Tom Edmunds (Warrington)
- Ted Kristiniak Jr. (Langhorne)
- Robert Elsner (Chalfont)

SOUTHAMPTON LIONS

- Frank (Socks) Kolanko
- Marie Kolanko
- Pete & Janet Hughes
- Al & Mary Beckett
- Bob & Diane Redstreak
- Bill & Jennifer Redstreak

- Bud & Ann D'Agostino
- Alke & Ron Richardson
- Faith Costantini
- Sam Costantini
- Paul and Elsie Carter
- Kay Gunther
- Paul Gunther
- Bob and Eileen Campbell
- Jeremy & Joshua Redstreak
- Debbie Redstreak
- John A. James
- John & Jean Link
- Terry & Leona Fenningham
- John & Clair Redstreak
- Katrina Annan
- Joseph E. Warner, III
- Jim Davis
- Gloria J. Supin
- Harvey & Joan Field
- Gov. Bob & Harriett Elsner
- Charles Geib, Jr.

QUAKERTOWN LIONS

- Jack Edge
- Rick Adams
- "Bud" Blough
- Ron Heller
- Ernie Kully
- Bill Moyer
- Art McGrann
- James Stoneback
- Marvin Frederick
- Bob Newhard
- Richard Rosenberger
- Reuben Myers

QUAKERTOWN LIONS (cont.)

- George Trumbauer
- Bob Ulrich
- John Ulrich
- Don Young
- Bill Geiger

NEWTOWN LIONS

- Marion E. Satterthwaite
- Gene Kennedy

HILLTOWN TOWNSHIP LIONS

- Larry Correll
- Nick Decker
- Jack Fox
- Gerry Gulick
- Jim McIntyre
- Bob Peterman
- Paul Rivest
- Earl Smith
- Roy Wainwright

CONGRATULATIONS TO PENNRIDGE ALL - STARS

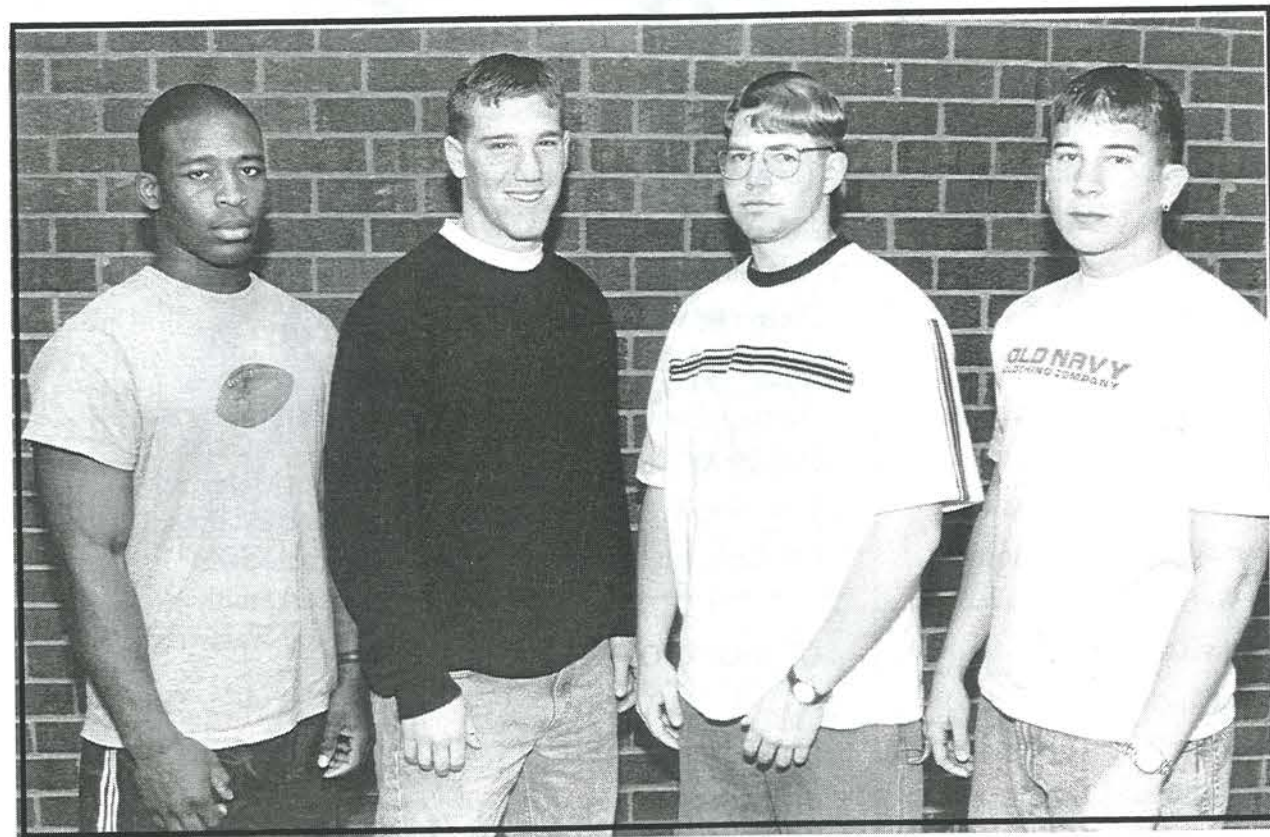

Left to Right: FLOYD TURNER • KEITH MOORE • MATT DONAHUE • MIKE BUNTING • Not in Photo • RYAN SHAAK



PERKASIE LIONS
SERVING THE COMMUNITY
SINCE 1938

NORTH ALL-STAR COACHES • 1998

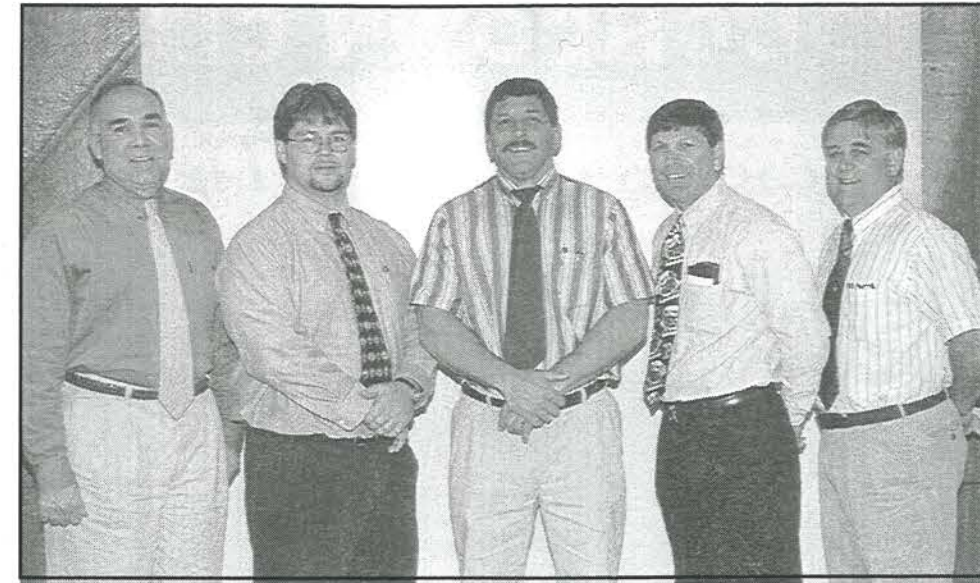

From left to right: Sam Evans • Vince Bedesen •
(Head Coach) Mike Ortman • Bud Ortman • Bruce English

SOUTH ALL-STAR COACHES • 1998



From left to right: Mike Pacitti • John Karpinski • Tony Dragani
(Head Coach) Biz Kenny • Dave Noltek • Barry Kline • Lorenzo Henderson
Jennifer Uter (Trainer)

Harry S. Truman High School

TOUCHDOWN CLUB

Proudly Presents the 1998 Tiger All-Stars!

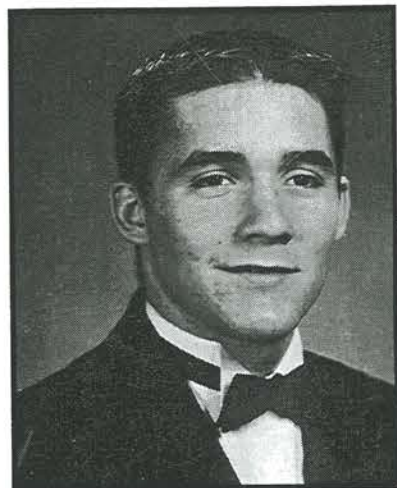

KEVIN McARDLE

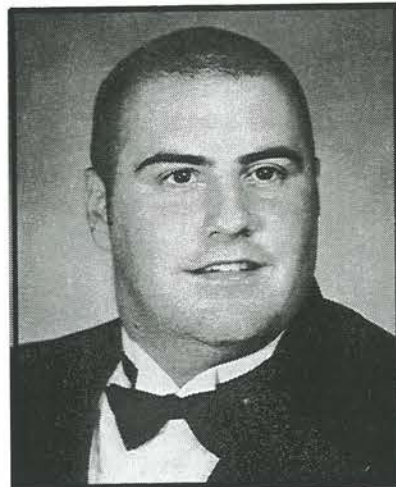

DON THOMAS

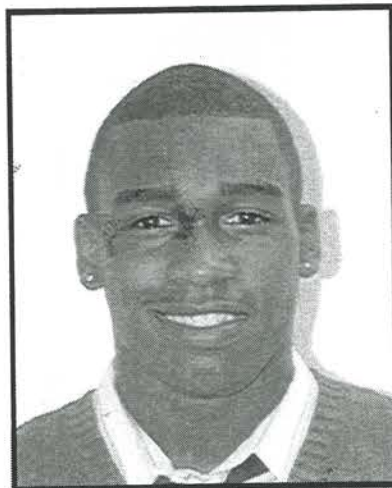

JEFF RODGERS



JOHN TUTINO

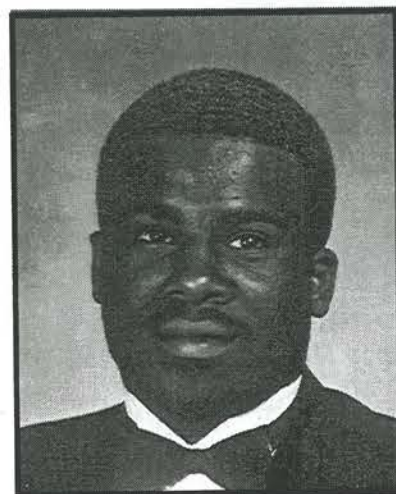

TONY FOBBS

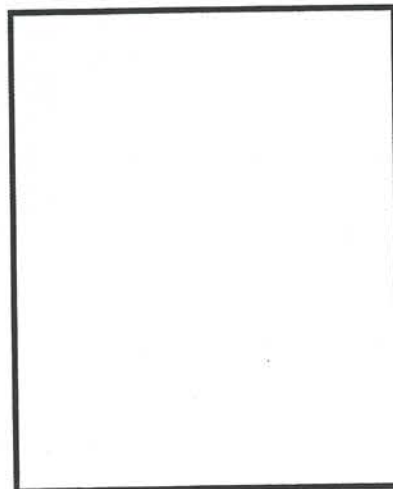

RYAN CUNNINGHAM

**WILLIAM TENNENT H.S.
FOOTBALL BOOSTERS**

"1998"

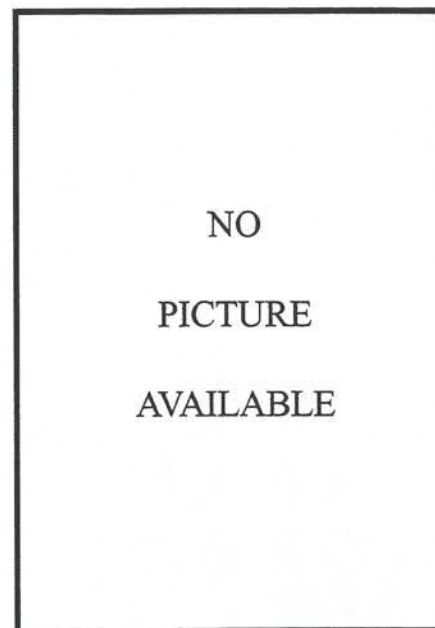

KEITH CROWELL

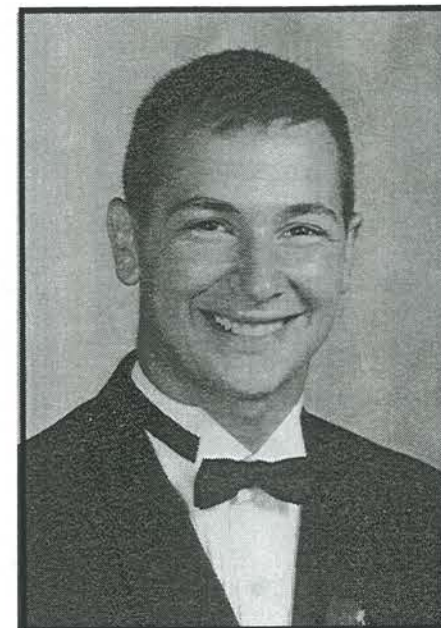

LOU FANELLI



ROB VERNELLE

**PROUDLY PRESENTS THE
PANTHER ALL-STARS**



presenting

THE BEST SENIOR PLAYERS FROM THE NORTH

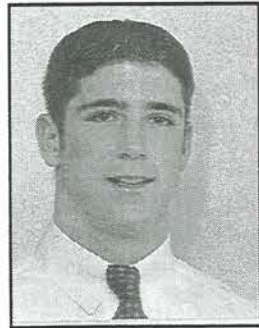

MIKE BECKER

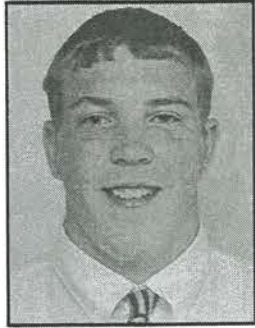

MIKE BENCOTER

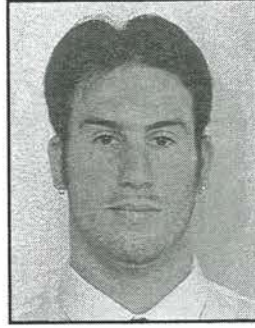

TONY BEVIVINO

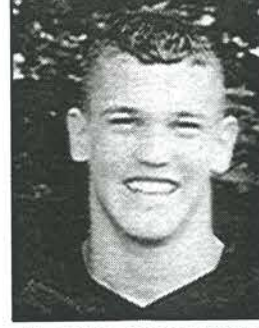

JACOB BLOMGREN

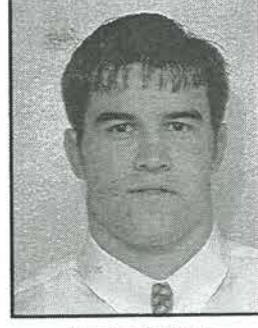

DAN BOYLE

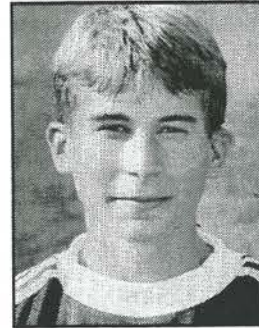

MIKE BUNTING

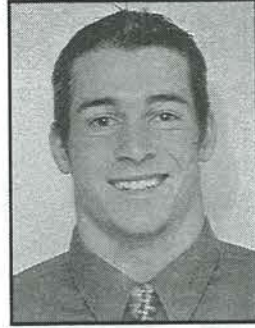

BILL CHIEFFO



NICK CROGNALE

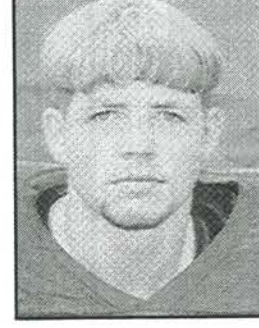

MATT DONAHUE



JOE EWASHKO



LOU FANELLI

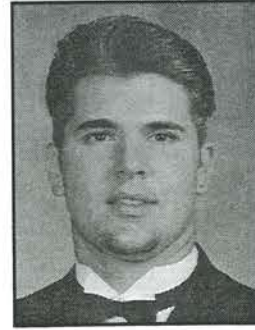

ED JOHNSON

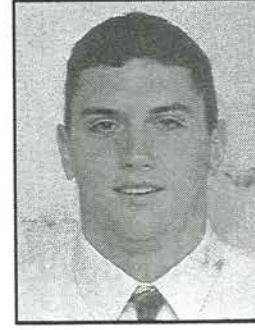

MIKE LACEY

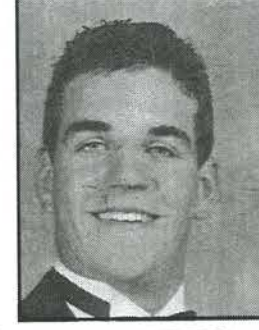

DREW LUDWIG

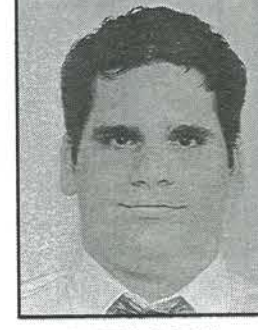

PAUL MARINI

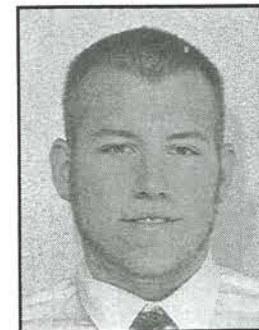

MIKE MCGOULDRIK

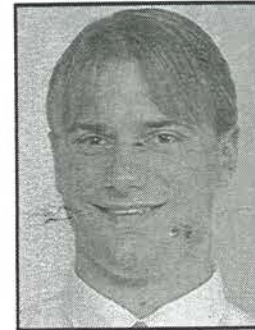

BRIAN MILLER



KEITH MOORE

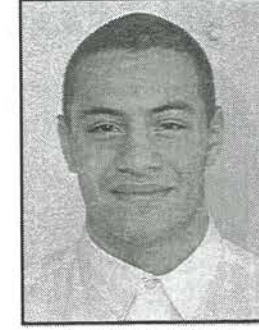

MARIO PALENA

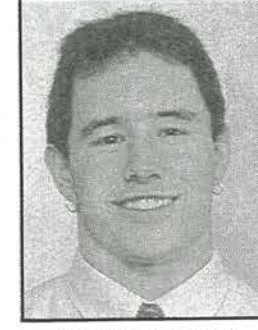

COREY POTTER

North Players

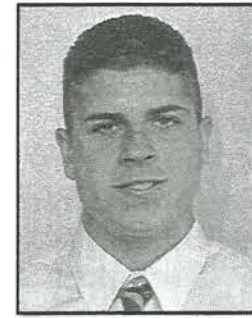

RYAN RUPPRECHT

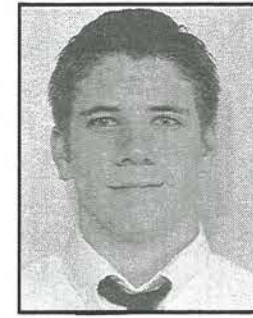

MATT SCHAUB

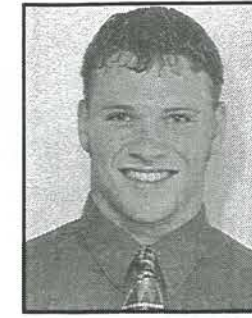

TODD SCHULBERGER

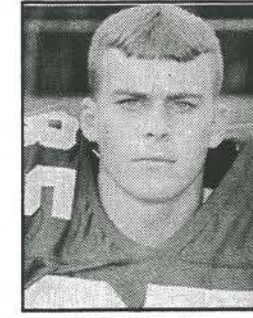

RYAN SHAAK

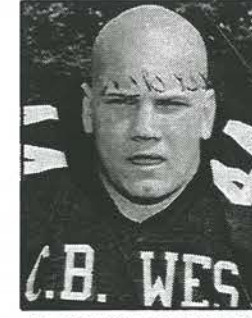

JACK SHACKLETON

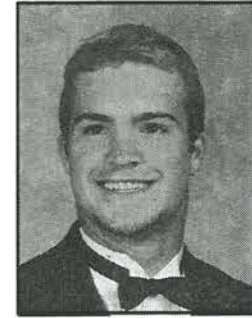

JACK SMITH

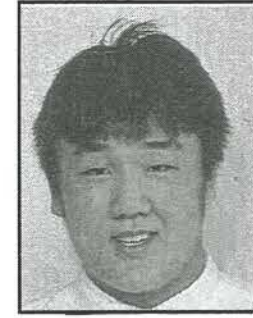

BRIAN SONG

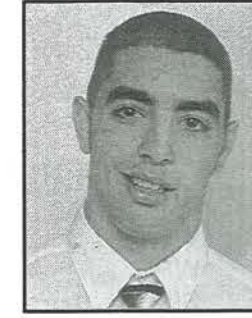

MANNY STOUPAKIS

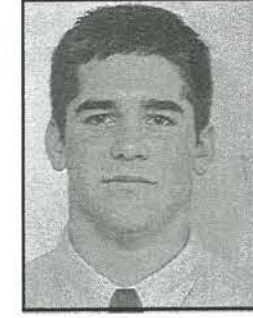

DAVE TITUS

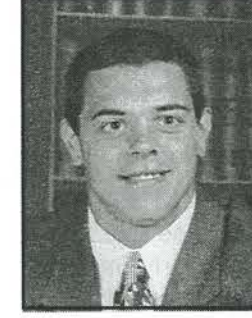

SCOTT TOKA

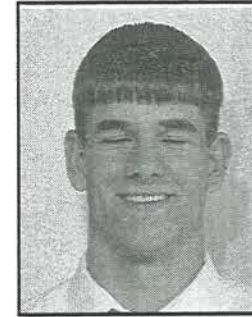

JOHN TRACZYKIWICZ

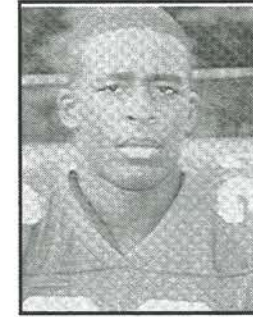

FLOYD TURNER



ROB VERHELLE

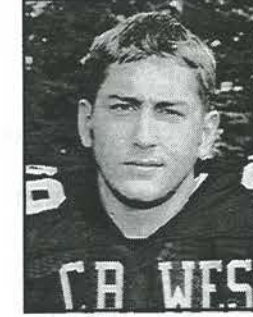

GREGG WARD



SCOTT WARDEN

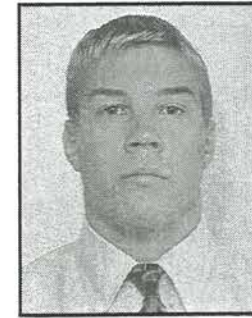

ERIC WARG

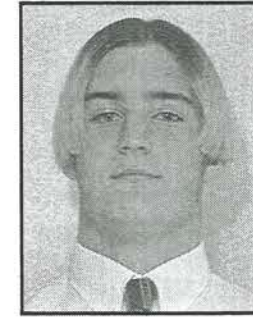

ANDREW WERTZ



JASON YAICH

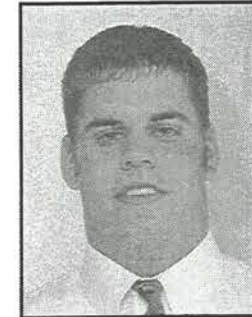

CHRIS YATES

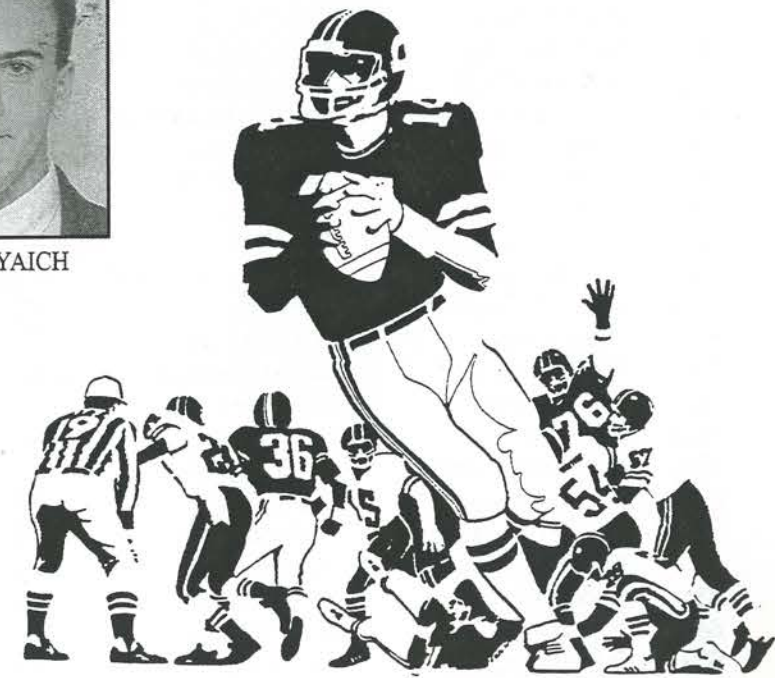

**1998 LIONS
ALL-STAR FOOTBALL TEAM
NORTH**

Head Coach- Mike Ortman - Council Rock H.S.

Assistant Coaches:

Vince Bedesem.....Council Rock H.S.
Bruce English.....Council Rock H.S.
Sam Evans..... Council Rock H.S.
Jeff Hollenbach..... Pennridge H.S.
Bud Ortman..... Council Rock H.S.
Shawn Ortman.....Council Rock H.S.

Trainer:.....Mike Horan

North Coordinator: Donald Young - Quakertown H.S.



**Officials for the
All-Star Football Game**

Game Announcer - Dan Taylor
Spotter - Ray Conville (Perkasie Lions)
Referee - Bill Bradley
Umpire - Chuck Meyers
Linesman - Steve Gozur
Line Judge - John Bradbury
Field Judge - Kevin McGinley
Back Judge - John Croman
Side Judge - Neil Evans

**Chain Crew for the
All-Star Football Game**

Chris Graham
Terry Henry
Ralston Hedrick



Officials - Jim Maconaghy

Banquet Speaker - Dave Keeny,
Head Coach: Kutztown University

**1998 LIONS
ALL-STAR FOOTBALL TEAM
SOUTH**

Head Coach: Biz Keeny - Bensalem H.S.

Assistant Coaches:

Barry Kline.....Bensalem H.S.
John Karpinski.....Bensalem H.S.
Tony Dragani.....Bensalem H.S.
Michael Pacitti.....Bensalem H.S.
Lorenzo Henderson...Bensalem H.S.
Dave Nolter.....Bensalem H.S.

Trainer - Jennifer Uter, ATC - Bensalem H.S.

South Coordinator - Mike Clark - Morrisville H.S.

NORTH ALL-STAR ROSTER

#	NAME	SCHOOL	POSITION	HT.	WT.
6	Joe Ewashko	Quakertown	WR	6'1"	170
7	Tony Bevivino	C.B. East	WR	6'2"	215
8	Dave Titus	C.B. West	SE/DB	6'0"	180
10	Keith Moore	Pennridge	QB	5'11"	185
11	Mike Becker	Arch Bishop Wood	QB	6'0"	200
12	John Traczykiwicz	Arch Bishop Wood	SE	6'4"	210
20	Jacob Blomgren	C.B. West	DB	6'1"	185
22	Corey Potter	C.B. West	DB	5'10"	200
30	Dan Boyle	Arch Bishop Wood	FB	5'10"	190
31	Bill Chieffo	Council Rock	RB/DB	5'9"	170
33	Lou Fanelli	William Tennent	FB/LB	6'1"	200
35	Scott Warden	C.B. West	RB	5'11"	180
40	Jack Smith	Council Rock	DB	5'9"	170
41	Mario Palena	C.B. West	WR/DE	5'11"	200
42	Eric Warg	Council Rock	FB	5'10"	175
50	Jack Shackleton	C.B. West	DE	5'10"	205
51	Ed Johnson	Council Rock	OL	6'6"	280
52	Nick Crognale	C.B. West	DE	6'0"	230
53	Brian Song	C.B. East	OL	6'0"	230
60	Matt Donahue	Pennridge	DL	5'11"	205
61	Andrew Wertz	Council Rock	LB	5'11"	210
62	Mike Lacey	Arch Bishop Wood	LB	6'0"	215
63	Todd Schulberger	Quakertown	LB	5'9"	180
64	Chris Yates	Council Rock	P	6'2"	220
65	Mike Bunting	Pennridge	K	5'8"	155
66	Scott Toka	C.B. East	DL	6'2"	230
70	Matt Schaub	Arch Bishop Wood	OL	6'1"	210
71	Mike McGouldrick	Quakertown	DL	6'1"	245
72	Drew Ludwig	Council Rock	OL	6'1"	210
73	Rob Verhelle	William Tennent	OL	6'1"	260
74	Jason Yaich	C.B. West	OL		
75	Paul Marini	C.B. East	OL	6'2"	290
76	Mike Benscoter	C.B. East	OL	6'2"	260
80	Manny Stoupakis	C.B. East	RB/DB	5'10"	175
81	Floyd Turner	Pennridge	DB	5'10"	180
82	Ryan Rupprecht	Arch Bishop Wood	DB	6'0"	195
83	Brian Miller	Quakertown	TE	6'2"	215
84	Gregg Ward	C.B. West	TE	6'4"	220
85	Ryan Shaak	Pennridge	DE	6'1"	195

SOUTH ALL-STAR ROSTER

#	NAME	SCHOOL	POSITION	HT.	WT.
6	Krishan Lewis	Bensalem	WR/DB	6'2"	198
7	Rob Dunner	Bensalem	QB/DB	6'0"	195
8	Jermaine Livingston	Morrisville	WR/DB	6'2"	160
10	Jeffrey Rogers	Harry S. Truman	RB/DB	5'11"	185
11	Jim Dietz	Neshaminy	QB	5'11"	165
12	Dave Schimpf	Pennsbury	QB/DB	5'11"	175
20	Aquil Flythe	Bensalem	TE/DE	6'2"	205
21	Kevin Mullins	Neshaminy	LB	5'11"	187
22	Keith Davis	Bensalem	RB/DB	5'9"	165
30	Bob Angelini	Morrisville	RB/DB	5'8"	165
31	Jason Scheerer	Harry S. Truman	WR/DB	5'10"	165
33	Frank DiSandro	Neshaminy	RB	5'10"	170
35	Jim Kelly	Neshaminy	DB	5'10"	180
40	Randy Thomas	Bensalem	FB/DE	6'1"	225
41	Kevin McArdle	Harry S. Truman	WR/DB	5'11"	165
42	Keith Johnson	Pennsbury	RB/DB	5'8"	160
50	John Hanes	Conwell Egan	OL/DL	5'10"	180
51	Paul Copenhafer	Pennsbury	TE /DE	6'2"	190
52	John Tutino	Bensalem	OL/LB	5'8"	200
53	Steve Mason	Bensalem	FB/DL	6'0"	195
60	Jim Clayton	Pennsbury	OL/DL	6'2"	320
61	Don Thomas	Harry S. Truman	OL/DL	5'11"	265
62	Josh Secoda	Conwell Egan	TE/LB	6'1"	165
63	Antoni Fobbs	Harry S. Truman	FB/DL	5'6"	190
64	Brad Morgan	Pennsbury	OL	6'2"	245
65	Paul Yeager	Bensalem	OL	6'0"	235
70	Greg Mininger	Neshaminy	OL/DL	5'11"	190
71	Craig "Tex" Lough	Pennsbury	K/P	6'0"	175
72	Brian Fennimore	Morrisville	OL/DL	5'10"	200
73	Ryan Cunningham	Harry S. Truman	OL/DE	6'1"	230
74	Josh Vetter	Neshaminy	K	6'2"	190
75	Nick Lombardo	Bensalem	OL/DL	6'1"	290
76	T.J. Tignor	Pennsbury	FB/LB	5'10"	180
80	Jim Roberts	Pennsbury	WR/DB	5'11"	185
81	Josh Burden	Pennsbury	WR/DB	6'1"	160
82	Mike O'Brien	Neshaminy	TE/LB	6'2"	210
83	Mike Kelly	Neshaminy	DB	5'10"	180
84	Adam Behar	Neshaminy	WR/DB	6'0"	175
85	Jason Jonigkeit	Neshaminy	WR	5'11"	160

presenting

THE BEST SENIOR PLAYERS FROM THE SOUTH

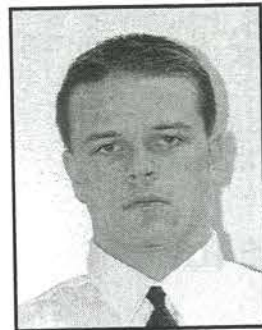

BOB ANGELINI



ADAM BEHAR



JOSH BURDEN

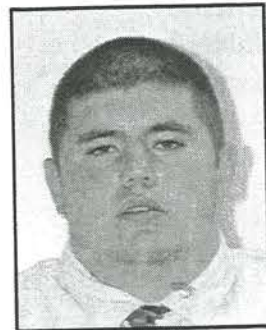

JIM CLAYTON

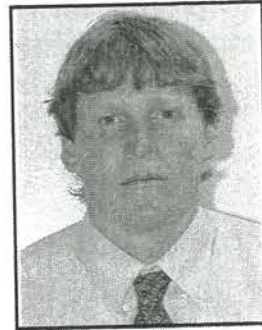

PAUL COPENHAVER

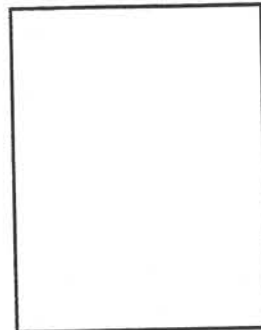

RYAN CUNNINGHAM

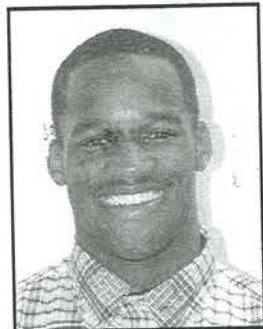

KEITH DAVIS



JIM DIETZ

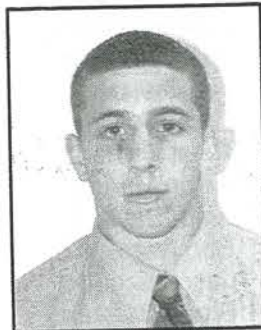

FRANK DiSANDRO

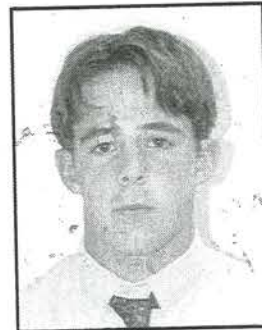

ROB DUNNER

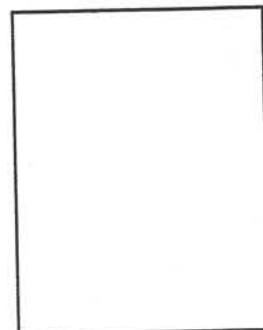

BRIAN FENNIMORE

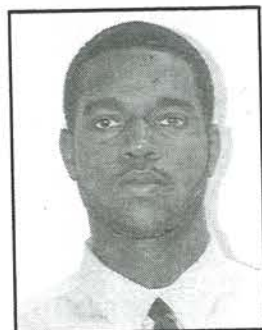

AQUIL FLYTH

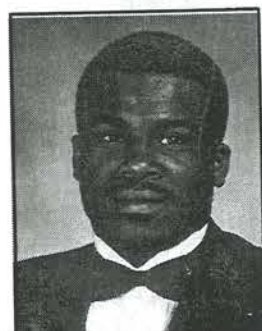

ANTONI FOBBS

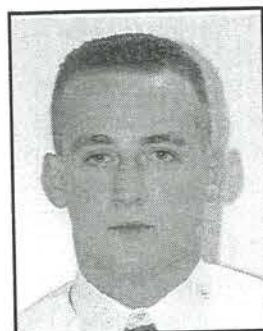

JOHN HANES

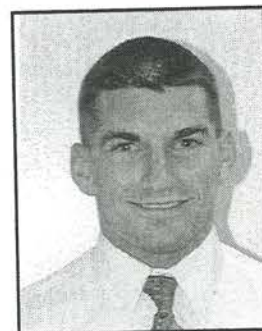

KEITH JOHNSON

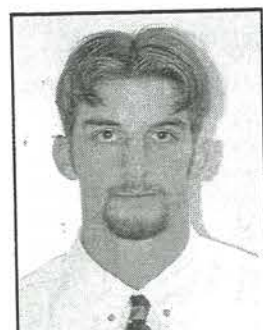

JASON JONIGKEIT



JIM KELLY

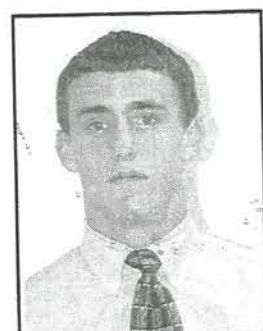

MIKE KELLY

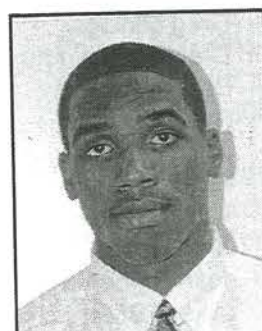

KRISHAN LEWIS

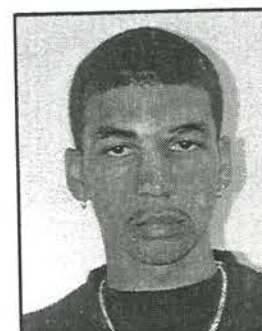

JERMAINE LIVINGSTON

South Players

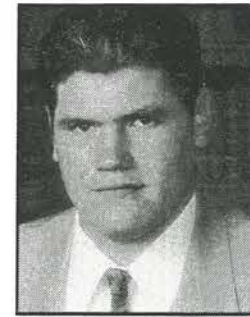

NICK LOMBARDO



CRAIG "TEX" LOUGH



STEVE MASON

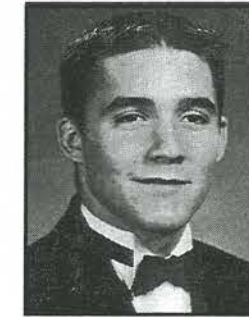

KEVIN McARDLE



GREG MININGER

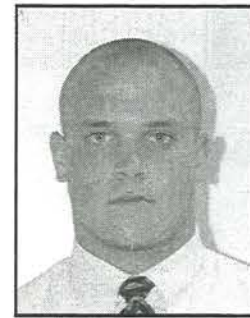

BRAD MORGAN



KEVIN MULLINS



MIKE O'BRIEN

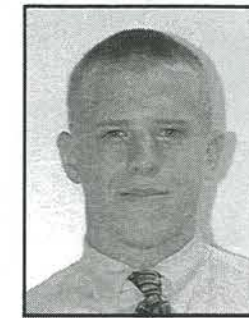

JIM ROBERTS

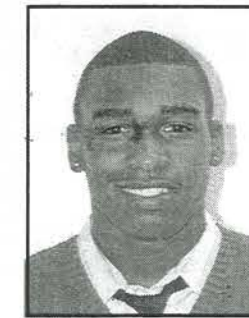

JEFFREY ROGERS

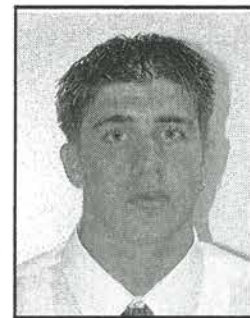

JASON SCHEERER



DAVE SCHIMPF



JOSH SECODA

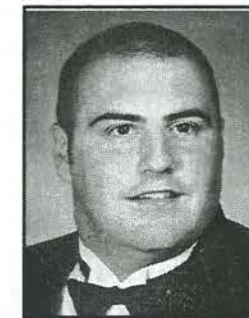

DON THOMAS



RANDY THOMAS



T.J. TIGNOR



JOHN TUTINO



JOSH VETTER



PAUL YEAGER

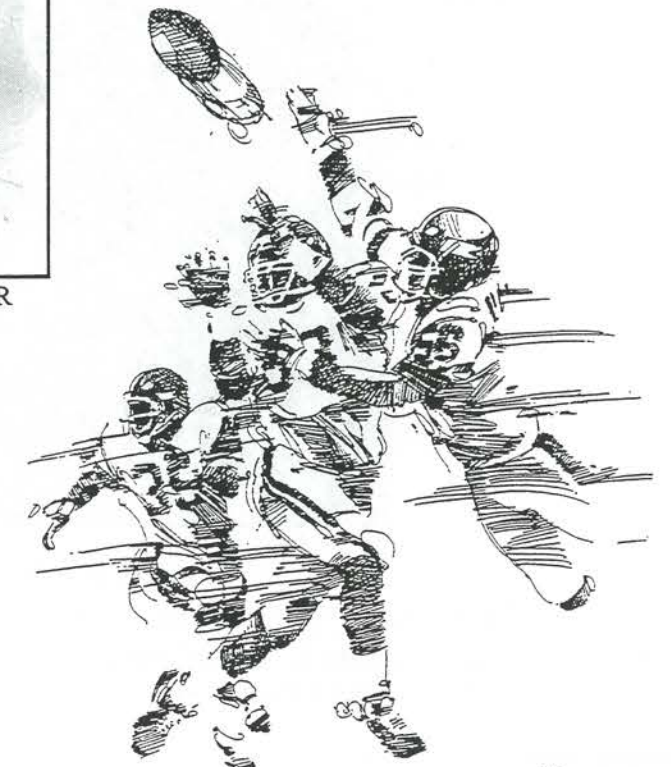

North Cheerleaders 1998



Council Rock High School Cheerleaders

Standing: Coach Pacitti • Coach Charlton

Back Row, L. to R.: Pam Hauseman • Danica Taylor • Melissa Snyder
Dever Sweeney • Ellie Skinner • Jodie Applegate

Front Row, L. to R.: Katie Carlin • Stephanie Roth • Jen O'hanlan
Nicole Forlaro • Kelly Finn • Sarah Armes

South Cheerleaders 1998

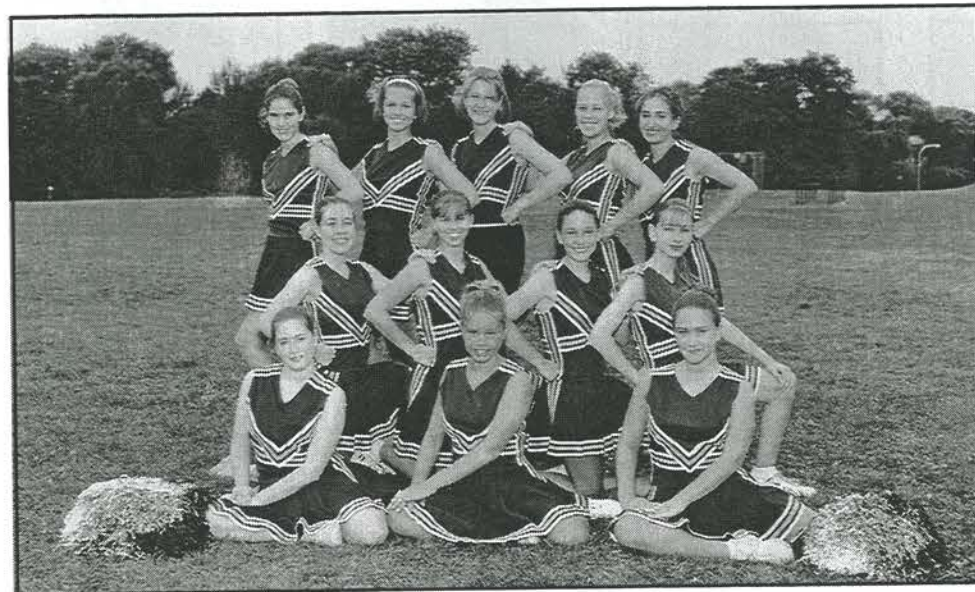

Bensalem High School, Cheerleaders

Top Row, L. to R.: Gina Ryan • Stacey Palio • Shaina Robinson • Suzanne Geissel • Kim Block
Second Row L. to R.: Connie Miraski • Maureen Richardson • Allyson Gross • Julie Staffieri
Third Row L. to R.: Amy Manning • Amy Rothman • Lauren Gummel

This page purchased by the Yardley-Makefield Lions Club for its Members and their firms

Good Luck!

EDWIN N. POPKIN
ATTORNEY AT LAW

THE LOFTS AT OXFORD VALLEY
SUITE 300
174 MIDDLETOWN BOULEVARD
LANGHORNE, PENNSYLVANIA 19047

TELEPHONE:
(215) 752-7117
FAX (215) 752-1038

Steven E. White
Chemistry Lab Supervisor

MMA Laboratories
2 Pheasant Run
Newtown
Pennsylvania 18940
Phone: (215) 579-7500
Fax: (215) 579-7591

MMA Laboratories

Congratulations to our All Stars!

JOHN E. "JACK" BRADY
ATTORNEY AT LAW

SUITE 206 HESTON HALL
1790 LANGHORNE-YARDLEY ROAD
YARDLEY, PENNSYLVANIA 19067
(215) 493-2043

**Best Wishes for a Great Game
and a Great Future to our All Stars!**

LLOYD H. KLATZKIN, CPA
LLOYD H. KLATZKIN, CPA, PC
364 WEST TRENTON AVENUE
MORRISVILLE, PENNSYLVANIA 19067
(215) 428-4720

CONGRATULATIONS AND BEST WISHES, ALL-STARS!

DOUGLAS ELLIOTT
President

Survey America
1350 South Pennsylvania Avenue
Morrisville, Pennsylvania

Telephone: (215) 736-1600

*Best Wishes for a Great Game and
a great future, perhaps as Lions,
in the competition of life!
from Lion Bill Jones of
Yardley-Makefield*

VESPIA'S
Your Total Car Care Center

1977-1997 — 20 Years of
Excellent Service

Jeff Horne
STORE MANAGER

GOODYEAR

**Cooper
TIRES**

551 Lincoln Highway
Fairless Hills, PA 19030
Tel: (215) 295-6625
Fax: (215) 295-2601

PHONE
215-537-9500
800-822-3984
x206

FAX
215-535-5311

Ellis

QUALITY SINCE 1854

WILLIAM (BILL) J. MAHER, JR.
VICE PRESIDENT NATIONAL ACCOUNTS

2835 BRIDGE STREET, PHILADELPHIA, PA 879137

QUAKER COLOR

DIVISION OF McADOO & ALLEN, INC.

Box 219

Quakertown, PA 18951

(215) 536-3520 ■ FAX (215) 536-6464

CONGRATULATIONS TO
ALL THE BUCKS COUNTY
ALL - STARS



VALLEY PRECISION, INC
195 PENN AM DRIVE
QUAKERTOWN, PA 18951

• 536-0676 •



215-536-3077

FAX 215-536-4844

Bracalente Manufacturing Company, Inc.
is a family owned and operated
multifaceted precision machining facility.

Bracalente Manufacturing Company, Inc. supports the
Bucks County Lions Clubs, Bob Sands Memorial,
All Star Football Classic.

**PRECISION MACHINED PARTS
SCREW MACHINING, CNC MACHINING AND TRANSFER
MACHINING.**

We are an equal opportunity employer.

Since 1950

Thomas Bracalente

Ronald Bracalente

The Yardley-Makefield Lioness Club salutes the All Star teams, their coaches, and all those who have planned and made possible this event for the benefit of the well-being of Bucks County.



For information on membership or meeting schedules
Call Lioness Joan at 215-493-5124

Three Cheers for North and South!!!

ZOÉ POWER-SHERWOOD
ASSISTANT VICE PRESIDENT
BANKING DEVELOPMENT OFFICER

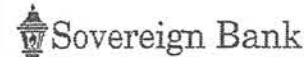

95 SOUTH MAIN STREET
YARDLEY, PENNSYLVANIA 19067 (215) 493-2084



70-069-CB1
95 SOUTH MAIN STREET
YARDLEY, PA 19067
PHONE: (215) 493-2180
FAX: (215) 493-9178

April M. Horton
Senior Personal Banking Representative
★
Committed To Quality Customer Service



DUBLIN, BUCKS COUNTY, PA 18917 USA
215-249-3543 FAX 215-249-3393

Bruce's Garage



Custom Pipe Bending
State Inspection - Auto Repair
Broad St. & Tollgate Rd.
Trumbauersville, PA 18970

(215) 536-7300

COMPLETE AUTOMOTIVE REPAIRS
EMISSION TESTING

BILL'S AUTO SERVICE
5TH & BUTTWOOD STREETS
PERKASIE, PENNSYLVANIA 18944
PHONE 257-5709

MON.-FRI. 7:30 TO 6:00 SAT. 7:30 TO 1:00

IF YOU WOULD LIKE TO HAVE
**YOUR COMPANY'S
ADVERTISEMENT**
APPEAR IN THIS BOOK
PLEASE CALL
FRANK (SOCKS) KOLANKO
357-0244

THE NEW Yardley



Inn

Casual Riverside Dining

Mon.-Fri.: Lunch & Dinner, Sat.: Dinner;
Sun.: A la carte Lunch with Mid-Day
Country Breakfast Specials 11-3:30;
Lounge: Daily from Noon.
Banquet Facilities • Entertainment Th.-Sat.

Corner of E. Afton Ave.
& River Road
(Delaware Ave.)

(215) 493-3800

"The setting is
incomparable."
"The cuisine
is excellent."
"An enormously
attractive place."
John V.R. Bull
Phila. Inquirer
June 16, 1991



The Lower Bucks County Chamber
of Commerce congratulates the
future business leaders of our county
who will be playing for the All Star
Team, both North and South.



Our Chamber is proud to have
served Bucks County
since 1958



LEVITTOWN
PRINTING
INC.

We make Printing Easy!

Competitive Prices
Campaign Printing Specialists
Desktop Publishing

1433 Haines Road, Levittown, PA 19057
(215) 945-8156 • FAX (215) 945-6144

Our Family Has Been Serving The Area
SINCE 1956



15% Off
Wedding Invitations
with this coupon

BCLF Expires February 1998

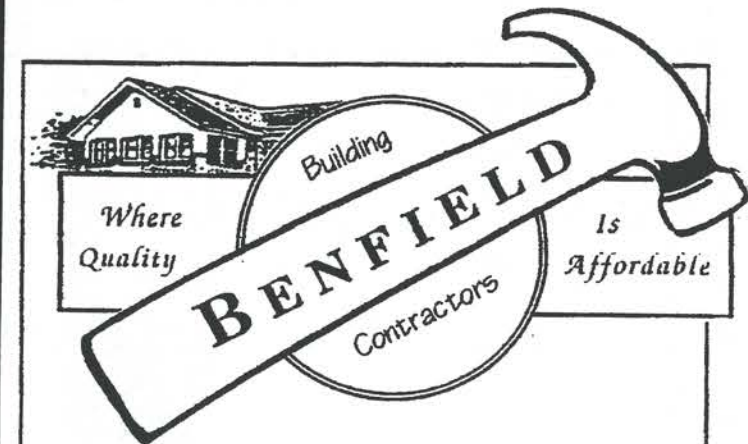

Custom Homes & Additions

"Quality Construction for 20 Years"



- Remodeling
- Baths / Kitchens
- Porches / Decks
- Garages

FREE ESTIMATES

Residential and Commercial
(215) 257-5944

A.J. Dembrosky Co., Inc.

PLUMBING
HEATING
AIR CONDITIONING

ADDITIONS
ALTERATIONS
RESTORATIONS

Commercial • Industrial • Residential

Energy Efficient Buildings

Over 50 Years of Service

1010 Rt. 113 • Perkaspie, PA 18944 • 215-257-1144

*Systems that take rinse water only
from clothes washing machines
and recycle it to flush toilets.*



Ed Dembrosky
(215) 257-1144

1010 Route 113
Perkaspie, PA 18944

Discount
Opticians

**glasses
galore Inc.**

1 Hour Service in Most Cases
\$49.95 Single Vision \$69.95 Most Bifocals
Complete
Includes- Frame, Lenses, & Tint

FAIRLESS HILLS SHOPPING CENTER
451 South Oxford Valley Road
Fairless Hills, PA 19030
MON.-FRI. 10AM to 9PM
SAT. 10AM to 6PM SUN. Noon to 5PM
(215) 547-5470

Phone-215-249-3246

Route 313, Dublin, PA



YOUR HOSTS-GERRY, JACK & FRANK KNISLEY
"WE TREAT YOU RIGHT!"

BALLOW'S SHOES

**SHOES FOR THE
ENTIRE FAMILY!**

308 Mill Street
Bristol, PA 788-2857

Most Major Credit Cards, Checks, & MAC Accepted

HOURS:
Mon., Thurs., Fri. 9-9
Tues., Wed., Sat. 9-5:30

In-Stock Wide Width
Sneakers For the
Entire Family!

Area's Largest Selection
of X-WideWidths and
Hard to Get Sizes.



BRIAN J. McAULAY, D.C.
FAMILY CHIROPRACTIC

ATRIUM PROFESSIONAL BUILDING, SUITE 7
YARDLEY NEWTOWN RD. & TERRY DR.
NEWTOWN, PENNSYLVANIA 18940
(215) 860-7275

Estate Jewelry

(215) 968-4778
FAX: (215) 968-9604



THE NEWTOWN JEWELERS™
21 South State Street
Newtown, PA 18940

CHERYL J. DURR-SMITH

WILLIAM C. SMITH

**We're
different.**

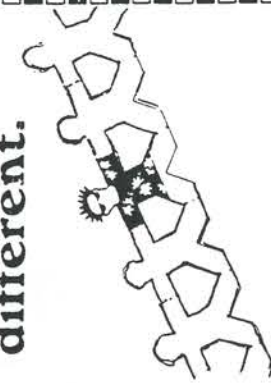

the frame game

DO IT YOURSELF & CUSTOM FRAMING
"Not Just Another Frame Shop"
Large Selection of In-Stock
Moldings, Mats & Prints Friendly Atmosphere.
Expert Instruction & Design Consultation
Great Savings
690 Stony Hill Rd. 24 Richboro Rd.
Yardley, PA 19067 Newtown, PA 18940
321-9141 860-8727

Cesare's
RISTORANTE

Fine Italian Cuisine Since 1947

1407 Radcliffe Street 788-3831 Bristol, Pennsylvania



Washington Crossing Travel
A FULL SERVICE AGENCY

LEISURE TRAVEL
CORPORATE TRAVEL

DODI ROSSER - OWNER
TRAVEL CONSULTANTS

1077 River Road, Suite #3
P.O. BOX 749
Washington Crossing, PA 18977
215 493-4677 Fax 215 493-4995

Anne Passanante
Linda Marshall
Jean Ferretti
Kathy Young
Robyn Fretz

PICKERING, CORTS & SUMMERSON, INC.

Consulting Engineers & Land Surveyors



Proud to be a part of the community

Since 1918, Pickering, Corts & Summerson, Inc. has provided our clients with excellence in engineering services.

- ★ Municipal Engineering
- ★ Land Planning & Development
- ★ Land Surveying
- ★ Transportation Engineering
- ★ Bridge Inspections

PENNSYLVANIA OFFICE:
126 SOUTH STATE STREET
NEWTOWN, PA 18940
215-968-9300 FAX:215-968-3649

NEW JERSEY OFFICE:
1600 REED ROAD
WEST TRENTON, NJ 08628
609-737-2033 FAX:609-737-7306

An Equal Opportunity Employer



Levittown Parkway & South Olds Boulevard
FAIRLESS HILLS, PA

- Pat Deon Beverages
- Manhattan Bagel
- Lee's Hoagies
- Mid City Camera North
- First National Bank & Trust Co. of Newtown
- Liquor Store
- Fairless Hills Dental Ctr.
- Quality Furniture
- Fairless Hills Auction
- Weight Watchers
- Mailboxes, Etc.
- Hair Cuttery
- Little Caesar's Pizza
- Gant, Meyers, & Gillis Insurance Co.
- West Coast Video
- Sears Hardware
- Creative Jewelers
- King Buffet

A Great Place to Shop!

CUSTOMER SATISFACTION COMPOUNDED DAILY

PREMIER BANK

516 Second Street Pike
Southampton, PA 18966

215-322-5400

Member
FDIC

DISTRICT 14A - DIABETES AWARENESS

WE WOULD LIKE TO THANK THE LIONS
OF DISTRICT 14A FOR THEIR OUTSTANDING
SUPPORT OF THE 14-A DIABETES
AWARENESS PROGRAM

"IT WORKS"

FROM THE DESK OF

CENTER # 0155

**COUNCIL ROCK MEDICAL OFFICE
DR. THOMAS J. FOOTE**

444 South State Street
Newtown, PA 18940

Newtown Optical



127 S. State Street
Newtown, PA 18940
860-2255

OPTICIANS
Dennis Fittipaldi
Nancy Heller
Lynda Leone
Debbie Mumaw
Dave Dow

Daily.....9:30-5:30
Friday.....9:30-8:00
Saturday.....9:30-4:00
Additional Hours by Appointment
From 7:30 a.m. to 9:30 p.m.
In Home Service Available

AUSTIN-BRIGGS

EXPERT
COLOR
MATCHING



DISCOUNT
WALLPAPER

COLOR COMPUTER ON PREMISES

276 W. Butler Ave.
Route 202
New Britain, PA 18901

Rick Austin
(215) 230-8000
Fax (215) 345-8164

Hunting & Fishing
Equipment

Sporting Goods
& Trophies

WELLINGTON SPORTING GOODS



(215) 723-6217
BOB WELLINGTON

140 MAIN STREET
SOUDERTON, PA 18964



1962

36 YEARS OF SERVICE

1998

**BUCKS COUNTY WATER AND SEWER
AUTHORITY**

BUCKS COUNTY, PENNSYLVANIA

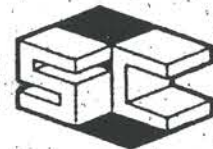

STORAGE CONCEPTS, INC.

275 Commerce Drive, Suite 130
Fort Washington, PA 19034
Phone: (215) 643-1441 FAX: (215) 643-0299
E MAIL: scipa03@aol.com

CLIFF FULLER
PRESIDENT

INFORMATION & STORAGE SYSTEMS SPECIALISTS

Compact Mobile
Storage Systems

Shelving For Files,
Archives, Books, Material

Suspended Files

Color Coded Filing
System & Supplies

Rotary Files

File Conversions

Records Control Systems

Vertical & Horizontal
Powered Carousels

Library Furnishings

Modular Work Stations

Mailroom Sorting Systems

M.D.S.

MODERN DATA SUPPLY

BUSINESS MACHINES

SALES, SERVICE AND SUPPLIES

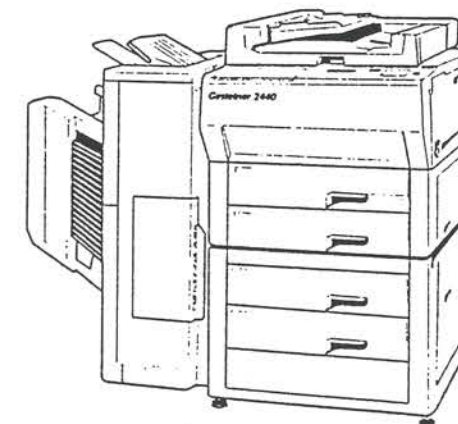

AUTHORIZED DEALER FOR

M Monroe Systems for Business, Inc.



215-672-2268

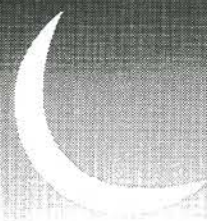

Last night, while you were sleeping, the companies we invest in were busy at work. In fact, in the past 24 hours...

- **Coca Cola** served **840 million** soft drinks
- **600 million** people used **Colgate** oral care products
- **General Electric** powered **more than half** the world's jetliners
- **450 million** people shaved with **Gillette** razors
- **McDonald's** opened **8** new restaurants and served **33 million** people
- **180 million** calls were made with **Motorola** cellular phones
- **Mobil** added **1.7 million** barrels of oil to their reserves
- More than **400 million** documents were printed by **Hewlett Packard**
- **Merck** spent **\$5 million** researching new drugs.

At the Spiropoulos Group of Smith Barney, we believe in investing in companies whose financial strength and global industry leadership produce reliable earnings and dividend growth. Our primary goal is to build and protect the purchasing power of your assets. We stay focused on long-term results. **What's in your portfolio?**

SMITH BARNEY

The Spiropoulos Group
114 South State Street
Newtown, PA 18940
(215) 968-0900
(800) 245-1559

William T. Spiropoulos John K. Whitehead Matthew Poprik
Maureen Cioppi-Grill Virginia Coniglio

WADE FUNERAL HOME

1002 RADCLIFFE ST.

BRISTOL, PA

788-9313



MOHAWK ELECTRIC SUPPLY

Wholesale Distributor

Quick & Dependable Service • Competitive Pricing
Serving the Electrical Construction Industry for 25 Years

1438 COUNTY LINE RD • P.O. BOX 188
HUNTINGDON VALLEY, PA 19006
TEL: (215) 322-2510 • FAX: (215) 322-9351

94 N. Branch St
Sellersville PA 18960

Phone: 215-453-8611
Fax: 215-453-8770
gageit@enter.net

Gage-It, Inc.

Pressure and Temperature Instrumentation

Ronald Benner
President



NIST TRACEABILITY
DIAPHRAGM SEALS



Southampton Beverage

BEER, SODA, SNACKS AND PARTY GOODS
LARGEST SELECTION OF IMPORTED BEER AROUND

MON. 11-7
TUES. 9-7
WED. THURS. SAT. 9-8
FRI. 9-9

453 SECOND ST. PIKE
SOUTHAMPTON, PA 18966
(215) 322-5530



Jaeger Electric Service, Inc.

ELECTRICAL CONTRACTORS

COMMERCIAL - RESIDENTIAL
INDUSTRIAL - MUNICIPAL

2321 N. Fifth St., Perkasie, Pa. 18944

JON JAEGER, Pres.

(215) 257-5543

KARL KLEMP

CHALFONT COLLISION CENTER

WE SPECIALIZE IN FOREIGN AND
DOMESTIC AUTOBODY REPAIRS
AND REFINISHING

PHONE (215) 822-8810

74 PARK AVE.
HARTZEL'S VILLAGE
CHALFONT, PA. 18914

MARJORIE P. KUHN
Administrative Manager

PENNRIDGE AIRPORT INC.
A FLIGHT LEVELS COMPANY

1100 N. RIDGE ROAD • PERKASIE, PENNSYLVANIA 18944-1799
215/257-0166 • FAX: 215/453-9303

If something happens to you, what happens to them?

If they lost you, would they
lose everything?
Protect your family from the
unexpected. Their future depends on
you...whether you're here or not.
The future starts tomorrow.

Contact us today:
18 North State St.
Newtown, PA 18940
(215) 579-9770



Licensed Insurance Investment Planning

Key West Financial Services





Lunch & Dinner - Tuesday thru Sunday
Breakfast - Sunday 9:00 AM to 12:30 PM

Main Street (Route 212) & Union Street
Richlandtown PA 18955

(215) 536-6239



BERGEY'S CUSTOM SERVICE
301 W. Walnut Street, Perkasie, PA 18944

GENERAL REPAIRS
--- 4 WHEEL ALIGNMENT ---
PA STATE INSPECTION
(215) 257-4787

DENNIS R. BERGEY - Owner WALT HUNSBERGER



County Line Road
Telford, PA 18969-1098
(215) 723-1157
FAX (215) 723-5315

543 Constitution Avenue
Perkasie, PA 18944
(215) 453-8448



PHONE 322-8835



DAVE'S VILLAGE PRODUCE
FRUITS & VEGETABLES, FRESH FISH
FRUIT BASKETS

REDWOOD VILLAGE
2ND ST. PIKE
SOUTHAMPTON, PA. 18966

1-800-331-5030
(215) 257-6848
Fax: (215) 453-0803



UNIVERSAL
Millwright Company, Inc.

EDWARD J. KLING, JR.
President

P.O. Box 219
Perkasie, PA 18944

Millwrights/Riggers/Welders
Pipefitters/Fabricators

PHONE 357-0244

OLYMPIAN • IBM • REMINGTON
SHARP • CASIO • TCA • SANYO

KOLANKO OFFICE MACHINES

ELECTRONIC CALCULATORS • TYPEWRITERS
CASH REGISTERS • FURNITURE • SUPPLIES

MARIE KOLANKO
FRANK KOLANKO

1281 DENNIS ROAD
SOUTHAMPTON, PA 18966

OXYGEN AND ACETYLENE GASES • WELDING SUPPLIES

Hance *Auto Radiator & Glass Shop*

659 N. MAIN STREET - DOYLESTOWN, PA.
PHONE: 348-5608

DITZLER PAINTS-BODY SHOP SUPPLIES-FIRE EXTINGUISHERS

ANDREW C. BAILEY JR., CPA
Exclusive Agent
Premier Service Agent

Allstate
You're in good hands.



Allstate Insurance Company
Buckingham Green, Unit 3, Box 1020
Buckingham, PA 18912
Bus (215) 794-5400
FAX (215) 794-5968

24 Hour a Day Service



ELBOW LANE DAY CAMP

828 ELBOW LANE, WARRINGTON, PA 18976



WE OFFER

- An outstanding instructional athletic program
- Four swimming pools with Red Cross instruction
- Wildercraft in our 8 acres of woods
- Arts, crafts, music, drama, ceramics
- Small groups and individual attention
- Options to tailor a program for your child

WE LIMIT OUR ENROLLMENT!

343-2120



ABOVE ALL
Chimney and Masonry



Chimney Cleaning
Chimney Caps • Chimney Relines
Tuckpointing • Brick & Block Work • Safety Inspections

H. Richard Garten

(215) 396-4294
1-800-499-CHIM

J.A. SWARTZ
HAULING & LANDSCAPING

DUMP TRUCK SERVICE, BACKHOE-LOADER,
DOZER, FIELD MOWING, YORK RAKING,
STONE, MULCH, TOPSOIL

946 CAMPTRAIL RD.
QUAKERTOWN, PA 18951

PHONE (215) 536-6472

SERVICES INCLUDE:

- ESTATE SALES
- APPRAISALS
- CONSIGNMENTS
- HAULING

CALL

215-538-0610

AUCTIONEER

MICHAEL L. GOEPFERT
SELLERSVILLE, PA 18960
RICHLAND AUCTION HALL



73 Old Dublin Pike
Doylestown, PA 18901

(215) 230-0112

HOURS:
Mon. thru Thurs. 11 a.m. to 9 p.m.
Friday 11 a.m. to 10 p.m.
Sat. & Sun. 11 a.m. to 9 p.m.

Petro-SINKLER Oil

We're more
more
more than just fuel oil.

Fuel Oil • Gas • Heat Pumps
Delivery • Service • Installation
Plumbing • Electrical Repairs

1-800-227-HEAT
357-7100

650 Knowles Avenue • Southampton, PA

The strength
of a big bank,
the service
of a small one.

Big banks offer a lot of features, a lot of resources.

Small banks treat you more like an individual. They take more time with you, go the extra mile, show you they care.

Now we'd understand if you said those are just words in an ad.

But, please, test us. Come in and see if we can give you what the big banks can. Really push us.

Watch us deliver with a smile. A thank you. A warm hand shake.

Anything to make you feel like a Prime customer.

Call Jim Lynch, President of Prime Bank at 215-836-2400 to find out more.



MEMBER FDIC

COMMERCIAL • INDUSTRIAL • RESIDENTIAL



**SOUTHAMPTON
WINDOW CLEANING
& JANITORIAL
SERVICE, INC.**

BUILDING MAINTENANCE
WALL WASHING
FLOURESCENT LIGHT CLEANING
CARPET CLEANING
FLOOR FINISHING
POWER WASHING
TRASH REMOVAL

TEL 215 357 1498 • FAX 215 355 1665
PO BOX 542 SOUTHAMPTON, PA 18966



- painting
- decorating
- aluminum siding
- roofing-seamless gutters
- soffits-fascia-trim capping
- storm windows-doors-shutters

h. ronald richardson
contractor
SOUTHAMPTON, PA 18966

355-2984

By Expressions

Manufactures and Food Distributors
Of Quality Products

Call (215) 536-2304 For a Distributor near you.



KURFISS REAL ESTATE
6038 Lower York Road
New Hope, PA 18938

Hellen I. Cannon
REALTOR® Coordinator, Christie's Great Estates



[215] 794 3227 Ext: 214
Direct: [215] 794 1314
hellen@kurfiss.com

HARCO PAPER COMPANY
WHOLESALE / RETAIL

Paper Products & Party Goods

1122 STREET ROAD
SOUTHAMPTON, PA 18966

677-8801
(Phila.)

357-5445
(Area)

215-348-1446 Tele.
215-348-3153 Fax

William E. Boger
• CERTIFIED PUBLIC ACCOUNTANT •

60 GREEN STREET
DOYLESTOWN, PA 18901
P.O. BOX 1271
DOYLESTOWN, PA 18901

Creek Side Inn

115 E. Butler Avenue
(Route 202)
Chalfont, PA
822-3976
Eat In or Take Out
OPEN 7 DAYS
Kitchen Hours: 11:00 a.m. to 11 p.m.
Sunday 12 noon to 6:00 p.m.



H.S. Roberts Nursery

Azaleas, Rhododendrons, & other ornamental shrubs
Perennials • Roses • Annuals

603 Newtown - Yardley Road
Newtown, PA 18940
(215) 968-4302

Allen Fidler

Betty Fidler

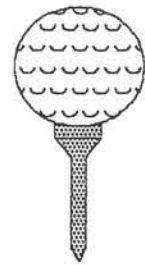

Improve Your Golf Swing

East Rockhill Township Golf Range

1418 Ridge Road, Perkasie - Open 7 Days A Week (seasonal)

Automated Token System \$4.00 Per Token (55 balls per Token)

For Information Call 215-257-9156



SALES RENTALS SERVICE

TOOLS - CONTRACTOR'S EQUIPMENT

Route 309 North
Quakertown, PA 18951 (215) 536-7874

MAC MEDICAL GASES, INC.

3575 Davisville Road
Hatboro, PA 19040

MEDICAL GASES & INDUSTRIAL

(215) 443-0782

INDUSTRIAL
• Propane • Oxygen • Nitrogen •
• Argon • Acetylene
Accessories - Equipment - Re-Testing

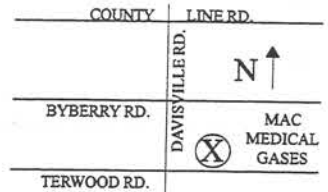

GAS REFILLS

1.00 OFF 1.00 OFF

- PROPANE
- CO² BEER MEISTER TANKS
- RV REFILLS
- HELIUM TANKS

One Coupon Per Cylinder • No Dealers

Newtown Floral Company
10 Swamp Rd. Newtown Pa
968-9555
We cater to you!
For all your floral needs.
www.newtownfloral.com

Phone: 968-5629

Irene Calabrese
BEAUTY SALON

13 N. State St.
Newtown, PA 18940
Personalized Styling



BEST WISHES
TO THE BUCKS COUNTY LIONS
ALL-STAR FOOTBALL
COMMITTEE
AND PLAYERS
FOR ANOTHER SUCCESSFUL
GAME

Lion Joseph E. Warner, III
Joan E. Warner
Jeanne E. McCarty

Office Hours By Appointment



DR. MARK E. BURTON
Podiatrist

1040 Pond Street
Bristol, PA 19007
(215) 785-5366
Fax: (215) 788-0645

603-604 Floral Vale Blvd.
Yardley, PA 19067
(215) 504-9266
Fax: (215) 504-8373

Certified

Emergency Service

Auto Care Center

PONTARELLI'S

Automotive • Marine
Service Center Inc.

Marc & Brian Pontarelli
70 Commerce Drive
Ivyland, PA 18974

(215) 442-0417
1-888-608-3679
Fax (215) 442-0426
<http://www.pontarellis.com>

(215) 536-8468
Fax: (215) 529-9705



C. W. Quintrell & Son

Remodel and Repair
General Construction

Cary Quintrell
Owner

P.O. Box 577
Trumbauersville, PA 18970

FREE SUNDAYS ★ NO CLUB FEES ★ 215-364-1140
4 MOVIES ★ 4 DAYS ★ 4 DOLLARS

Southampton Video

Hours
Monday - Thursday - 10-10
Sunday - 11-10
Friday - Saturday - 10-11
482 2nd St. Pike
Southampton, PA 18966



FIRST SAVINGS BANK OF PERKASIE

142 NORTH MAIN STREET
DUBLIN, PA 18917

DONALD S. RICHARDSON
MANAGER, DUBLIN OFFICE 249-3833

Like a good neighbor,
State Farm is there.®

JAMES M. SARACINO
Agent

191 West State Street
Doylestown, PA 18901
(215) 348-1300
Fax: (215) 348-0465



STATE FARM INSURANCE COMPANIES
HOME OFFICES: BLOOMINGTON, ILLINOIS



REED AND STEINBACH FUNERAL HOME, INC.

(Doylestown's Oldest Established Funeral Home)

182 WEST COURT STREET PHONE: 348-4543 DOYLESTOWN, PA. 18901
HARRY B. STEINBACH, JR., F.D. H. BOYD STEINBACH, F.

Winderman
Caplan
Slavin
& Co.

Accounting, Taxes,
Financial Services

(215) 322-2399
662 Second Street Pike
Southampton, PA 18966

Marc L. Slavin

Registered Representative of
HD VEST
FINANCIAL SERVICES

Securities Offered Through
H.D. VEST INVESTMENT SECURITIES, INC.
433 East Las Colinas Blvd., Third Floor
Irving, Texas 75039 (214) 556-1651

CHERRY LANE
FLORISTS

Weddings • Funerals • Banquets
Dry Arrangements • Fruit Baskets
Gifts • Fresh Flowers • Plants



355-6430

LORRAINE SEITZINGER
757 Street Road at Cherry Lane
Southampton, Pa. 18966



MAR-VAN INDUSTRIES, INC.

117 MIDDLE ROAD, P.O. BOX 144, DUBLIN, PA 18917
(215) 249-3336
FAX: (215) 249-1239

Custom and Standard Kitchens and Vanities European Style Cabinets

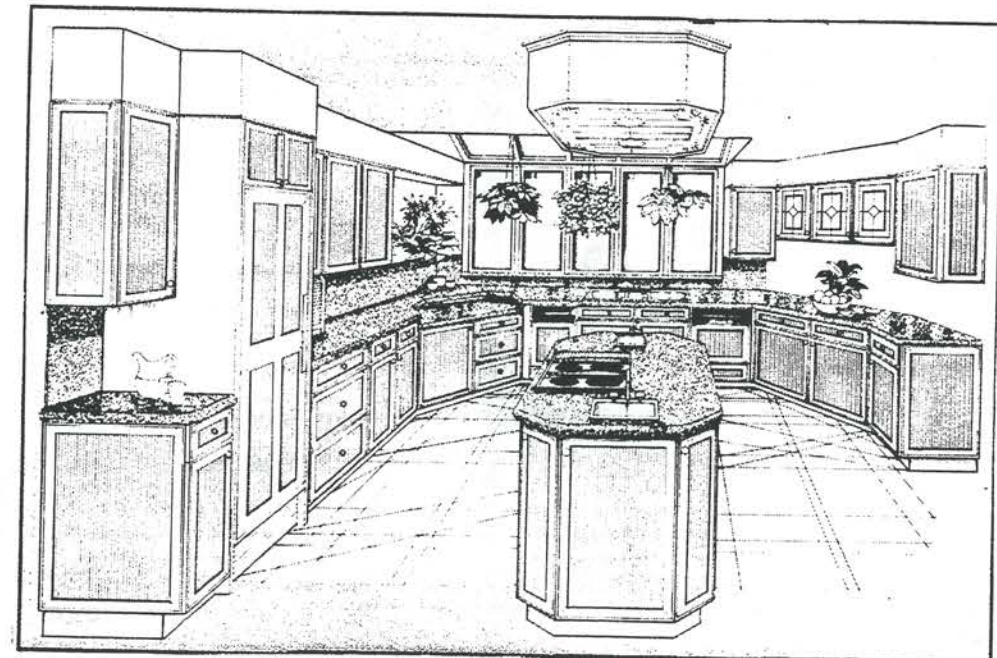

Synthetic Marble and Onyx Products Laminated Counter Tops and Specialty Items

Kitchen & Bath Division
117 Middle Road
Dublin, PA 18917

Marble Onyx Division
104 Mill Street
Dublin, PA 18917

(215) 249-3336

Gerry Geroni, Founder

Katherine Geroni • Jerry Geroni, Jr. • Ralph Geroni

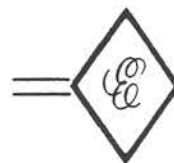

Esten Lumber Products

Pallets & Industrial Lumber Products
2015 Trumbauersville Road
Quakertown, PA 18951

(215) 536-4976



"Where Quality
and Service
is Our Tradition"

Maggio's

Famous Pizzas & Ribs

233 2nd Street Pike
Southampton, PA 18966

322-7272

TAKE OUT • DELIVERY • DINING IN

MIKE & BEV CAREY'S
NEW BRITAIN INN

OPEN 7 DAYS

Seafood & Sandwiches

Rt. 202, New Britain
348-1968



BARRY LUFF'S SUNOCO
ULTRA SERVICE CENTER
WASHINGTON & ELM STS.
NEWTOWN, PA. 18940
215-968-4455 - FAX 968-3935

BARRY LUFF - OWNER



TOPSOIL

SCREENED FARM TOP SOIL

Bedding mix with leaf mold or composted manure
Triple ground hardwood bark mulch
and economy mulch



JEFFREY SPARKS EXCAVATING

4094 Burnthouse Hill Rd
Buckingham (Doylestown)

• WE DELIVER •

345-4481
443-7277



- TAKE OUT
- CATERING
- GOURMET

"THE BEST HOAGIES IN YARDLEY"
7E. AFTON AVE. • YARDLEY, PA 19067
Walter J. Bitterlich, Proprietor
PHONE: (215) 493-9030 • FAX (215) 369-0223

Stephenson's Auction

1005 Industrial Blvd.
Southampton, PA 18966
322-6182

Offers a complete Auction Service
Handling Estates, large & small
On-Site or in our Gallery
Auctions - Appraisals - Liquidations

WARDS RENTS

TOOLS & EQUIPMENT
SALES • SERVICE • RENTALS
Everything for home & industry

Special Events

Everything for any
special event or party
Tents • Tables • Chairs



816 Second Street Pike Southampton, PA

POLARIS
RECREATIONAL
VEHICLES

ARTIC CAT
SNOWMOBILES

TRUMBAUER'S
LAWN & RECREATION INC.

WHEEL HORSE TRACTORS & MOWERS
CUB CADET POWER EQUIPMENT
LAWN BOY & ECHO LAWN EQUIPMENT
KARAVAN & WELLS CARGO TRAILERS

420 W. PALETOWN RD.
QUAKERTOWN, PA 18951

215-536-5186

Allied Electronics, Inc.

Specializing in Automated Fuel Delivery and
Monitoring Systems • Member P.E.I.

Ron Walker
General Manager

215-788-4943 Ext. 332
800-223-3619
Fax 215-785-5335
internet ron@alliedelectronics.com
P.O. BOX 624
2210 FARRAGUT AVENUE
BRISTOL, PENNSYLVANIA 19007

KIDS - PARENTS
AUTO INSURANCE
GREAT RATES
FOR YOUTHFUL &
INEXPERIENCED
DRIVERS

WATSON, McCORMICK & KING, INC.



Call Kathy or Donna
(215) 348-9063

Replacement Windows
Wood • Vinyl • Aluminum

MODERNIZE



D & L INSTALLATIONS
Installer of Energy Efficient
Glass - Windows - Doors
and Storm Doors

Insulated Glass
Steel Doors

DENNIS McCARTHY
(215) 322-4203

BANNERS & SIGNS

FLAGS - LOGOS - SCREEN PRINTING - ENGRAVING

CUSTOM DESIGN SIGNS - BANNERS - NEON
4839 STREET ROAD, TREVISO, PA 19053
215-364-9061 **FAX 215-364-9063**

Ollard Stationery

963 STREET ROAD
355-2222

SOUTHAMPTON

Next to the Library & Fire House



FIRST TRUST BANK

Susan M. Schneider
Community Banking Manager
Hampton Square Shopping Center
376 Second Street Pike
Southampton, PA 18966
(215) 355-7551 Office
(215) 355-7595 Fax
<http://www.firsttrustbank.com>

WILSEY

TOOL COMPANY, INC

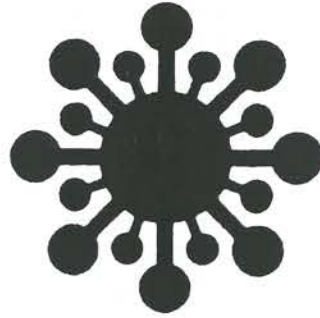

P.O. Box 699
140 Penn Am Drive
Quakertown, PA 18951
(215) 538-0800
FAX (215) 538-0860

WHY WE
COULD RUN
THIS AD
FOR THE
NEXT
20 YEARS.



Rick Hespell Auto Service

(215) 822-1056

57 SOUTH BRISTOL ROAD
CHALFONT, PENNSYLVANIA 18914

RICK HESPELL
Owner

A
*Commitment to
Community
Banking*



**THIRD FEDERAL
SAVINGS BANK**

579-4600

**3 Penns Trail, Newtown
6 Bucks County &
5 Philadelphia Offices**



Simply put, we're predictable. We always invest in the highest quality companies with consistent long-term performance. And our clients' investments have always had positive growth and tax efficiency. Year after year.

To learn more about our investment strategy, call David Robinson, Director of Marketing at (610) 293-3497.

The Rittenhouse Trust Company

Radnor, Pennsylvania

Two Radnor Corporate Center, Radnor, PA 19087-4570
Member F.D.I.C.



HERITAGE
INSURANCE SERVICES, INC.

BUSINESS & PERSONAL
INSURANCE SPECIALIST

EDWARD M. POKRYWKA
PRESIDENT

826 BUSTLETON PIKE/SUITE203
FEASTERVILLE, PA 19053
TEL: 215-322-8705 • FAX: 215-322-5854



FROZEN
CAKES



Southampton Dairy Queen
108 Street Road
Southampton, PA 18966
355-4604



GALZERANO FUNERIAL HOME

430 Radcliffe Street Bristol, PA 19007 (215) 788-2821 Louis A. Galzerano Jr. Director	3500 Oxford Valley Road Levittown, PA 19057 (215) 945-8484 Louis A. Galzerano III Director
---	--

Frank & Judy
Cipullo
Innkeepers

WASHINGTON
CROSSING INN

Open Tues.-Sun
Lunch from 11:30 a.m.
Dinner from 5:00 p.m.
Sunday Brunch 10:00-2:00
Dinner 2:00 p.m.

FINE DINING
American Tradition... Continental Cuisine



Serving Lunch - Dinner - Sunday Brunch
Live Entertainment Nightly - Lounge - Piano Bar
Routes 532 & 32 (River Road) • Washington Crossing, PA
215-493-3634

JOHN KENNEDY CHEVROLET, INC.
365 Street Road
SOUTHAMPTON, PA 18966



WALT YOUNG
General Manager
Bus. Phone (215) 364-7300

JOHN KENNEDY FORD
620 Bustleton Avenue
FEASTERVILLE, PA 19053



Taurus • Tempo • Escort • Mustang • Probe • Crown Victoria • Thunderbird • Aspire

KEEFE B. McCLOSKEY
General Manager
Bus. Phone (215) 357-6600
464-0600

RUSS SMALE INC.

Lee Stover Insurance

400 N. Main Street • Box 150
Sellersville, PA 18960
Ph. 215-257-2260 • fax 215-257-4264

Affiliated Agencies

T.W. Cooper Insurance
YS Insurance Assoc.

Business • Auto • Home • Life

Andrew R. Smale, CIC
President



(215) 345-8790



TRANS SHOP

Quality Automatic Transmission Repairs
Foreign/Domestic State Inspection

ERIC ERMIGIOTTI
JOHN SWARTZ

300 S. Main Street
Doylestown, PA 18901

EXPIRATION DATE: 12/22/98

\$99 PREFERRED RATE

Valid Any Evening, Sunday - Thursday - Deluxe Suite Only
Friday - \$139

IMPORTANT: When making your reservation, kindly inform the reservationist of your Voucher. Vouchers cannot be used toward Special, Corporate, Holiday Rates or purchase of a gift certificate. Guest using this Voucher or making reservations must be 21 years of age. This special is valued off Rack Rate. Only one Voucher may be used toward any evening at the INN OF THE DOVE. Not refundable for cash. All reservations are subject to availability of discount.

REDEEMABLE ONLY AT
3901 Old Street Road
Bensalem, PA 19020
(215) 238-3683

ISSUED BY:
All Reservations made with this voucher must be made directly to each location. Not valid on holidays.

**MORTGAGE BANKING
WITH A DIFFERENCE**
Low Rates • Local Presence • Personal Service

"courteous, prompt and valuable service...some very creative financial thinking for our personal needs." •David Lefkovitz, Professor Temple University & Nelle Berman, President of School of Music.

"a pleasure to recommend Ray... it wasn't an easy deal... unique business properties... would have fallen through if it hadn't been for Ray's stick-to-it-iveness and pleasant personality." •Neil Ellenoff, CPA Doylestown.

"pleasant and professional business experience...responsive and knowledgeable... several competitive alternatives." •President of a Large Bucks County Company.

"I highly recommend Ray and his dedication to assuring that his clients receive the best mortgage rate and service available. We were so pleased that we recommended him to our friends. They were equally delighted." •T.C. Onstott, Professor Princeton University & Nora Anderson-Onstott, President of Health Services Company.

"worked tirelessly to facilitate our relocation from Florida efficiently and at a very competitive rate." • Ian Priestnell, Sr. VP of BetzDearborn and Charlotte Priestnell.

Call Ray Sizer Today! (800)779-5274x108

**Arlington Capital Mortgage Bankers
4 Greenwood Square, Bensalem, PA**

- Free Pre-Approvals
- Jumbo Loans to 3 Million
- Construction Loans to 95% LTV
- No Income - No Asset
- No Employment Verified Loans
- Land Loans to 80% LTV
- Hundreds of Loan Programs
- Self Employed Borrowers Best Friend
- Purchase 95% Financing to \$400,000
- Impaired Credit Solutions

Licensed Mortgage Banker.
CT,DE,FL,MD,NJ,NY,PA & VA
Department of Banking Equal Housing Lender

SMG

SCHMELTZER • MASTER GROUP

Certified Public Accountants
& Business Consultants

Professional Corporation

400 Greenwood Avenue
Wyncote, PA 19095
(215) 572-7100
Fax (215) 572-5048
smg@smgpc.com

BARBARA DEITTER DRILL, C.P.A.

**ENERGY
EXPERTS
INC.**

High Efficiency
Heating & Cooling
Specialists

Jon LaRue
Bud Kingsbury

Box 2691, Doylestown, PA 18901
215-345-1082
Fax 345-5603

There is a Difference.

Kantner

Funeral Home

623 West Market Street
Perkasie, PA



257-7100

William H. Kantner, Supr.

Over 50 Years experience in Funeral Planning.

Dedicated Service from Our Family to Yours.

Drill Communications

Editorial Services
Newsletters Press Kits Speeches

HERB DRILL
(215) 968-4755
Fax 968-5421

22 Fir Drive
Richboro, PA 18954
E-Mail Address:
72204.1612 @compuser.com

- K-1 KEROSENE
- PROPANE
- DIESEL



YOUNG'S AMOCO & CAR WASH

"Self Service or Automatic Wash"

Route 202
New Britain, PA 18901
345-0636

Gary S. Parzych

TELEPHONE:(215) 536-3089
(215) 536-3341
FAX: (215) 536-6168

Eugene T. Parzych, Inc.

Building Contractor
Commercial • Industrial • Institutional
Alterations • Maintenance

P.O. BOX 48 • 2300 TRUMBAUERSVILLE ROAD
TRUMBAUERSVILLE, PA 18970

Center Line Mfg. Inc.

P.O. Box 205
Milford Square, PA, 18935
(215) 536-2135

Manufacturers of:

3-D Plastic Injection Molded & Vinyl

Die Cut Logos & Emblems For:

Automobile Dealers Boat Mfgs. & Dealers
Computer Equipment O.E.M. Applications

Industrial Engraving

*"Proud to be a Lion;
Privileged to Support Lionism"*

115



JOEL C. KRAUTHEIM
Plumbing & Electrical Contractors



581 Holland Road
Holland, PA 18966
Telephone (215) 357-5008

JOSEPH CARFI

GENERAL DAVIS HOUSE
Restaurant & Bar
TAKE-OUT AVAILABLE
(215) 322-1000

76 Street Road
Southampton, PA 18966



John J. Sibel
PRESIDENT

Churchville Auto Body
481 SECOND STREET PIKE • SOUTHAMPTON, PA 18966
PHONE 355-1777

Dr. Russell J. Flacco
Chiropractor

Doylestown
573 N. Main Street
Doylestown, PA 18901
(215) 348-9551

Somerton
12030 Bustleton Avenue
Philadelphia, PA 19116
(215) 969-8333

Member Somerton Lions

GREG EHRENZELLER



President

Gemm Landscaping Inc.

(215) 997-5528
P.O. Box 856
Montgomeryville, PA 18936

Read's Van Service, Inc.
250 N. Wood Street, Hatboro, Pennsylvania 19040
(215) 443-2770 Toll Free 1-800-523-6638
FAX (215) 443-2782

Atlas Van Lines Agent
World-Class Moving



**Spanninger,
Schantz
Group**

INSURANCE & FINANCIAL SERVICES

- Business Owner Policies
- Workers Compensation
- Contractors' Programs • Bonds
- "Hard To Place" Coverage
- Home Owners • Auto
- Fire • Liability • Health
- Life • Disability Income
- IRA Programs • Risk Management

536-4944

263 EAST BROAD STREET
TRUMB АуЕРSVILLE

FRONT END ALIGNMENT
AIR CONDITIONING SERVICE

TUNE UPS—BRAKES
INSPECTION & EMISSION

K M AUTO SERVICE
COMPLETE AUTO REPAIRS

LION KEN MOORE

For Appointment (215) 757-2719
525 BELLEVUE AVE. (RT. 513)
PENND EL, PA 19047

MidCityCamera

ONE HOUR PROCESSING
WE RESTORE OLD PHOTOS
INSTANT PASSPORT PHOTOS
FULL SELECTION OF CAMERAS
DARKROOM SUPPLIES

RICHBORO CROSSROADS PLAZA RICHBORO, PA. (215) 357-0100	CENTER CITY 13TH AND WALNUT ST. PHILADELPHIA, PA. (215) 735-2522	FAIRLESS HILLS DEON SQUARE FAIRLESS HILLS, PA. (215) 948-3800
---	---	--



**Gilmore
& Associates, Inc.**

Engineering
Site
Geotechnical
Services

331 Butler Ave.
New Britain, PA 18901
(215) 345-4330
Fax (215) 345-8606

184 W. Main St.
Trappe, PA 19426
(610) 489-4949
Fax (610) 489-8447

Providing Progressive Solutions for
Today's Challenges.



Geographic
Information Systems



Municipal
Engineering



Geoscience
Services



Wastewater
Systems



Governmental
Landscape
Architectural



Potable Water
Systems



Stormwater
Management



Groundwater
Development

(215) 673-8520
Fax (215) 673-8522



Mauker's Flowers
Gift & Gourmet Baskets

11714 BUSTLETON AVE. • PHILA. 19116

Edward Jones

Harvey E. Field
Investment Representative

Morelyn Plaza
1111 Street Road, Suite 304
Southampton, PA 18966-4250
Bus 215-355-9545

Serving Individual Investors Since 1871

C.R. Strunk Funeral Home, Inc.

Michael B. Schmauder
Supervisor

821 W. Broad St., Quakertown, PA 18951
(215) 536-6550

Bobby O's CATERING

Food
for all
Occasions



- Hot or Cold Buffet
- Fancy Party Trays
- Delivered to your Home, Office, Hall

803 Rozel Ave.
Southampton, PA 18966

357-9225

JAMES J. McGHEE
Funeral Home

JAMES J. McGHEE

JOHN A. McGHEE

JOSEPH M. McGHEE

Second St. Pike and Belmont Ave.
Southampton, PA 18966
355-0902

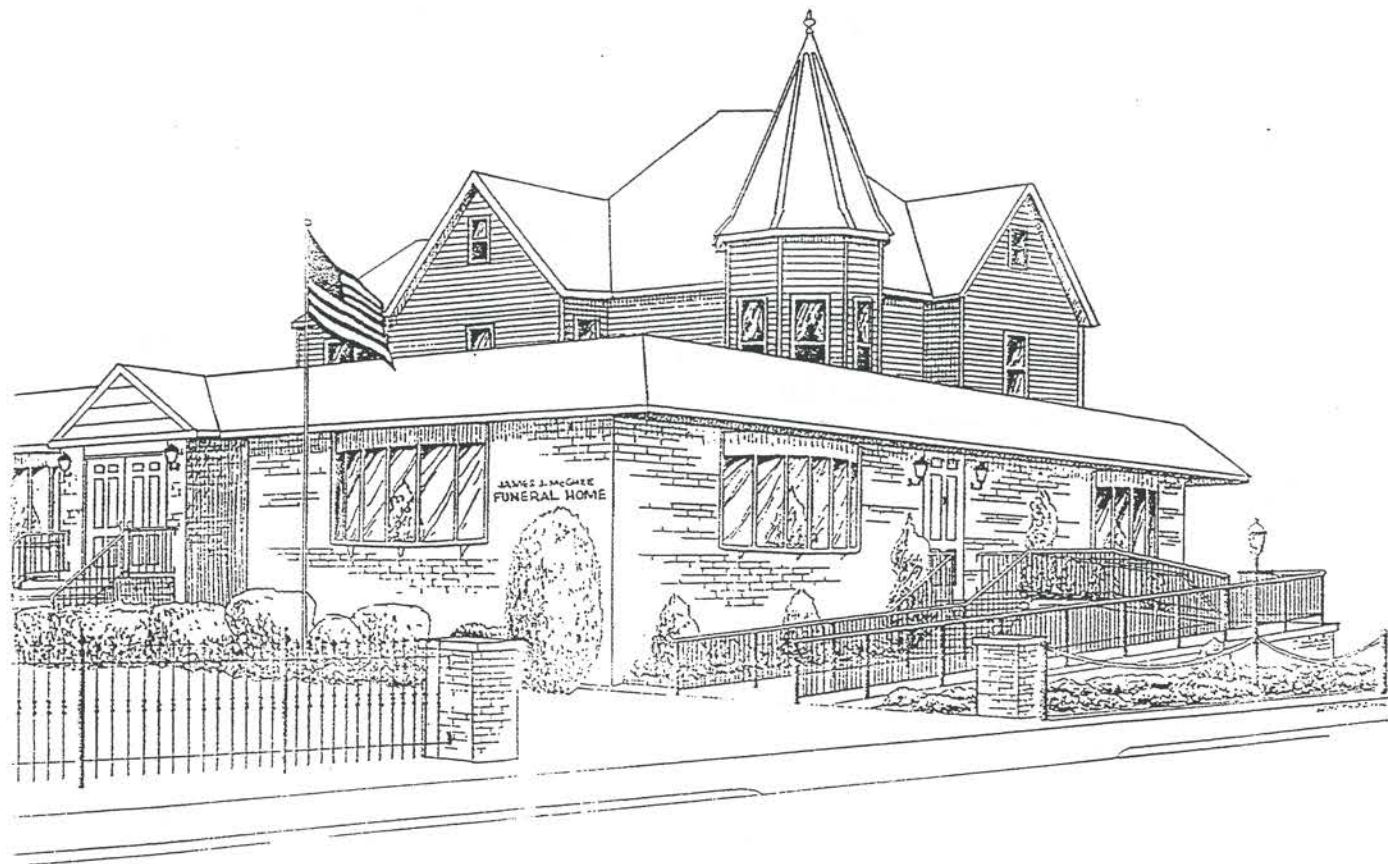

OUR FAMILY
OFFERING PERSONALIZED SERVICES
TO
YOUR FAMILY
FOR AT NEED AND PRE-NEED FUNERAL SERVICES

(215) 443-8656

(215) 443-8655
FAX (215) 443-0247



D. J. PINCIOTTI CONST. CO., INC.

UTILITY CONTRACTOR
SANITARY SEWER • STORM DRAINAGE
WATER MAIN CONSTRUCTION
EQUIPMENT RENTAL

DANIEL J. PINCIOTTI

6 COMMERCE DR.
IVYLAND, PA 18974

McKenney's Garage



Complete Auto Repair's

Certified
Tires • Brakes • Batteries
State Inspection • Emission Inspection

Vince Weiss

(215) 357-9192 • Fax (215) 953-9851
491 2nd Street Pike • Southampton, PA 18966

TRACKS - ROLLERS - SPROCKETS - IDLERS
PIN AND BUSHING SERVICE - REBUILDING

PHILADELPHIA TRACK & ROLLER INC.

CHARLES W. ORMSBY
(215) 357-2466

8025 Torresdale Avenue
Philadelphia, PA 19136
(215) 333-8660

Think Locally Act Locally



Your Future is Our Future

At QNB, we're committed to improving the quality of life right here in our community each and every day.

The QUAKERTOWN National Bank



The Quakertown National Bank, PO Box 9005 Quakertown, PA 18951-9005 (215) 538-5600
With Offices in: Quakertown, Pennsburg, Coopersburg, Dublin, Perkasia

Member FDIC



Auto Ironics

STATE SAFETY AND EMISSION INSPECTION

Repairs on:

- Carburetors
- Fuel Injection
- Tune-ups
- Brakes, Shocks
- Steering, Alignment
- Electrical Wiring
- Computer Systems
- Power Accessories
- Starting, Charging
- Heating, Air Condition

995 B. Jaymore Rd., Southampton, PA 18966 (215) 357-2877



Olde Towne
Real Estate



MICHAEL J. HUGHES
REALTOR®
Multi-Million \$ Producer

183 Bustleton Pike
Feasterville, PA 19053
Office: (215) 322-2020
FAX: (215) 322-7687
Pager: (215) 818-0652

Phone (215)860-6110

Pager (215)818-6498

ADAPT ELECTRIC

P.O. BOX # 643 HOLLAND, PA. 18966

24 HR. EMERGENCY SERVICE

ROBERT J. GRISAN HOLLAND LIONS MEMBER

DINING EXCELLENCE FAMILY PRICED!

FRANK'S ORIGINAL STEAK SANDWICHES

Rt. 309, Plaza Shopping Ctr.
Quakertown, Pa.
Phone: 536-9973

Pizzas - Clams

Route 309
Hatfield, Pa.
Phone: 822-9420

Upper Bucks County's Oldest Law Firm

Established in 1895

- Banking & Lending • Business & Tax
- Civil & Criminal • Corporate Formation
- Debt Collection • Estate Planning
- Estate Administration • Family Law
- Municipal • Partnerships
- Personal Injury • Real Estate
- Title Insurance • Zoning

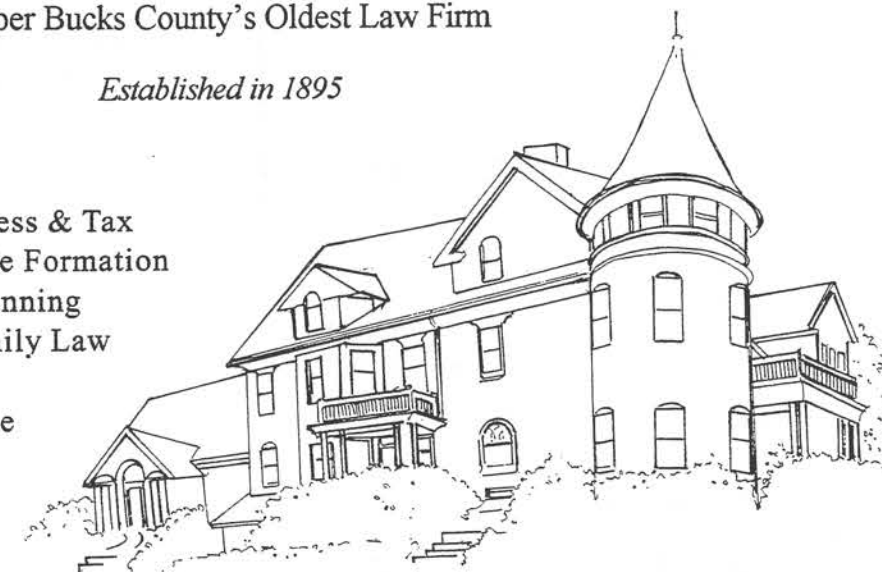

GRIM, BIEHN & THATCHER

Evening and Weekend Appointments Available

6th & Chestnut Streets
Perkasie, PA 18944

257-6811

314 West Broad Street
Quakertown, PA 18951

536-1200

4259 Swamp Road, #128
Doylestown, PA 18901

348-2199

121



JERRY LEPPING
President

1 Cambridge Lane
Newtown, PA 18940
Fax: (215) 860-9116
(215) 860-2600

Corporate Dept.:
(215) 860-2602
Nationwide:
(800) 242-6606



Robert W. Campbell PCC
Chairman, Host Committee

LIONS 80th INTERNATIONAL CONVENTION
Philadelphia, Pennsylvania, USA
July 1.2.3.4.5 1997

1085 Spring View Drive
Southampton, PA 18966

(H) 215-355-1997
(B) 215-322-6630
FAX - 215-322-2627

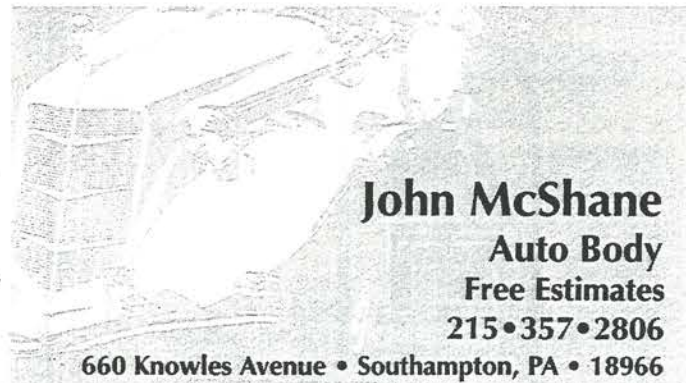

John McShane
Auto Body
Free Estimates
215•357•2806
660 Knowles Avenue • Southampton, PA • 18966



ROMAN FRIEDMAN
(215) 364-6440

CLEAR VISION OPTICAL

- Designer Eyewear
- Most Insurances Accepted
- Special Care For Children's Eyewear
- Same Day Service Available
- Prescriptions Filled

Mon. & Tues. 10 - 5
Thurs. & Fri. 10 - 8
Sat. 10 - 3
Wed. & Sun. Closed

606 - C 2nd Street Pike
Southampton, PA 18966
Oscar Huber Center

RAINES POOL SERVICE CENTER



GENERAL KNOX COMMISSARY
WASHINGTON CROSSING, PA 18977

(215) 493-8288

Dept. of Agr. # BU9192

REASONABLE RATES

SCHOOL BUSES • VANS

"The Practical Alternative"

SAFE, EFFICIENT TRANSPORTATION
SCHOOLS • CHURCHES, CIVIC & YOUTH GROUPS
SMALL GROUPS WELCOME



LEVY SCHOOL BUS CO.

Lehigh Valley
610-434-5110

114 E. Broad St.
Trumbauersville, Pa • 18970-0580

Quakertown
215-536-4567

Office Phone
215-357-2226 or 2227 Fax - 215-357-5399



CLINGER TRANSPORTATION
and RIGGING, Inc.
The Carrier That Cares

Howard Clinger 67 N. Hilltop Drive
President Churchville, PA 18966

COMMON CARRIER SERVING 48 STATES AND THE PROVINCE OF ONTARIO, CANADA



VOLUNTEER OPTOMETRIC
SERVICES TO HUMANITY

Wishes to Thank All Lions Clubs
For Their Financial Support and for
Collecting Eyeglasses

51 Cloverly Drive
Richboro, PA 18954
(215) 357-3096



FROM TAKE OUT
TO
FULL FAMILY DINING

WARMINSTER RICHBORO
215-674-5550 215-322-9272

NEW HOPE
215-862-1740

Thank you, From Your Favorite Pizza Shop.

HOURS: MON. TO THURS.-11 AM to 11 PM, FRI. AND SAT.-11 AM to 12 MID., SUN.-12 NOON to 11 PM

"WE ONLY SERVE THE BEST"

WHERE



ALL KINDS



OF PEOPLE



KICK OFF



THEIR SHOES.



"Best Baby Bucks in Bucks"

Sunday Breakfast 9am to 2pm
Banquet Facilities for 15 to 65 people
Take-out available

1500 Bustleton Pike • Churchville, PA 18966
357-3967

DOMINICK'S PIZZA
ITALIAN RESTAURANT
THE FINEST PIZZA IN THE U.S.A.
DINING IN ALSO



OVER 25 YEARS OF EXPERIENCE
VINNY SCAVO - Prop.

Route 532
Washington Crossing, PA
(215) 493-1376

1069 Second Street Pike
Richboro Plaza, Richboro, PA
(215) 396-1952 or (215) 396-1952



HIGH REACH

PERFORMING AT A HIGHER LEVEL

RENTALS
SALES
SERVICE
PARTS

"A FULL RANGE OF MAKES & MODELS TO MEET YOUR JOB REQUIREMENTS"

**TOLL-FREE
(800) 562-6740**

Free Demonstrations

- Narrow Aisle Models
- Rough Terrain Models
- From 16 Feet to 176 Feet
- Articulated Boom Models
- Propane, Gas, Diesel, Electric Models

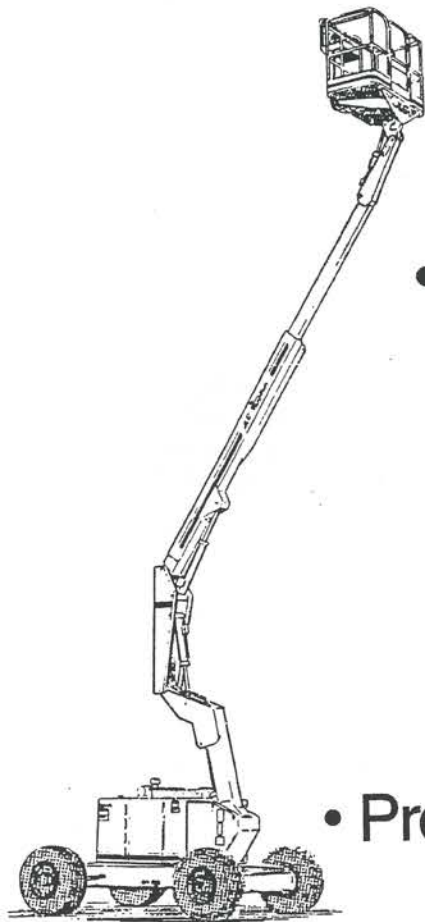

The Authorized Genie Dealer for NJ, PA, DE

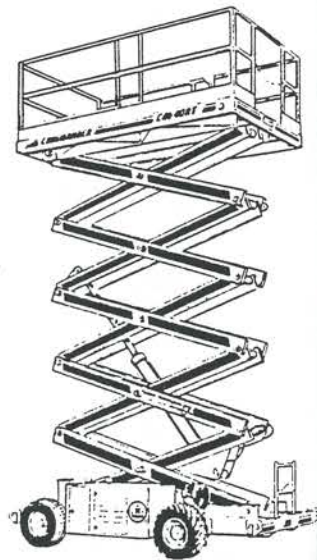

The Intelligencer.

for the best coverage of

Bucks County

ALL STAR

FOOTBALL GAME

stories • photos • statistics

FOR GUARANTEED HOME DELIVERY CALL

345-3020 • 249-0500

WWW.intelligencer-record.com

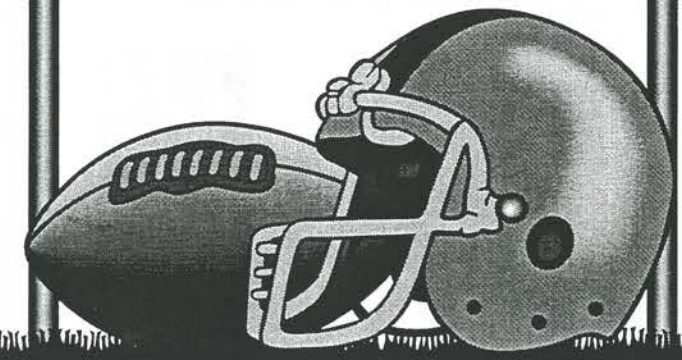

Lee's Hoagie House

CALL AHEAD
Your order will be waiting

322-2500

26 Second Street Pike
Southampton, PA 18966

Where County Line Road Meets Second Street Pike

*Let Our Team
Cater to Yours!!*



STORE HOURS
MON - FRI: 10-4
SAT: 10-4
(Closed Mon. in June, July, & Aug.)

SOCK OUTLET

MANUFACTURERS OF ATHLETIC AND WORK SOCKS

We also sell T-shirts & sweats
(Open to the public)

215-322-8161

1442 COUNTY LINE ROAD
HUNTINGDON VALLEY, PA 19006

SUBURBAN KITCHEN COMPANY, INC.

ROBERT J. MOESER

(215) 357-7276

"Professionally Designing and Installing
Custom Kitchens Since 1958"

650 STREET ROAD, SOUTHAMPTON, PA 18966

EDWARD W. LAPINSKI, INC.

- EXCAVATING
- HAULING
- PAVING

SAND • STONE
TOP SOIL & FILL

BACK HOE
AND
FRONT END LOADER

536-2816

1475 ALLENTOWN ROAD
QUAKERTOWN, PA 18951

MAB PAINTS

M.A. BRUDER & SONS, INCORPORATED

JOHN MOFFETT JR.

Manager

FEASTERVILLE PLAZA • STREET RD. & BUSTLETON PIKE
FEASTERVILLE, PA 19053
(215) 355-3646
Fax: (215) 355-9251
Pager: (215) 980-0801

MAKING
AMERICA
BEAUTIFUL

(609) 397-0800



(215) 943-0894

H & H Pools Inc.

SERVICE AND CONSTRUCTION

HARRY G WILSON

Box 232
LAMBERTVILLE NJ 08530

BEER CITY

QUAKER VILLAGE SHOPPING CENTER

QUAKERTOWN, PA

(215) 538-0111

Summer Hours

Mon-Wed 9:30 - 8 • Thurs. & Sat. 9:30 -9 • Friday 9:30 - 10

Wide Selection of Micro Brews

SENIOR DISCOUNT Monday & Wednesday

5 Case Discount

B & J SHEET METAL INC.

JERRY SCHMIDT
President

1535 Allentown Road
P.O. Box 872
Trumbauersville, PA 18970-0872

Phone: (215) 538-9543
FAX: (215) 538-9586



SPECIALTY METAL FABRICATION FOR INDUSTRY

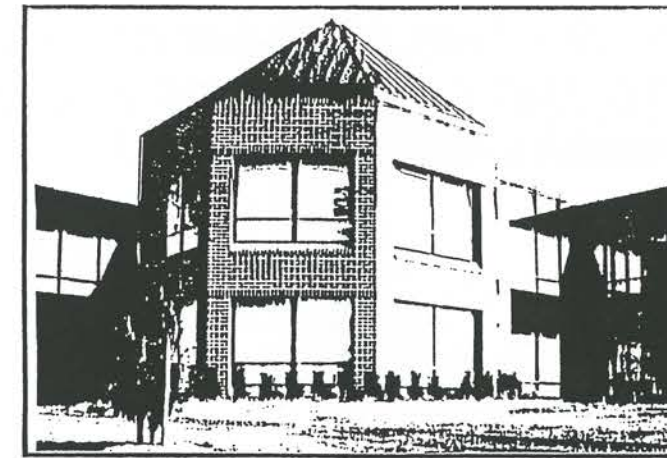

GROEN, LAVESON GOLDBERG & RUBENSTONE

FOUR GREENWOOD SQUARE
BENSALEM, PA 19020
(215) 638-9330

ONE PITCAIRN PLACE
JENKINTOWN, PA 19046
(215) 572-7756

GREENTREE PLACE
MARLTON, NJ 08053
(609) 983-3336

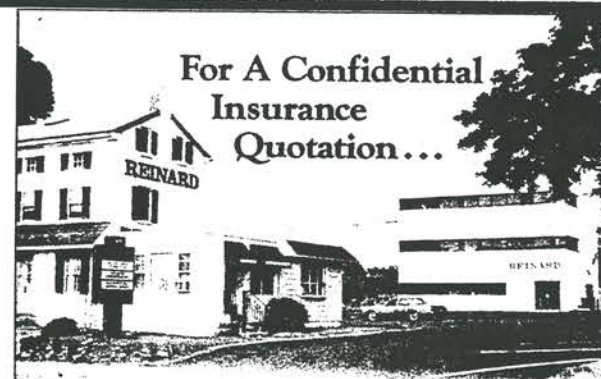

For A Confidential
Insurance
Quotation...

Give Us A Call.

The Reinard Agency will be happy to give you a free insurance quotation for all your business and personal needs. Our representation of most major Stock and Mutual companies enables us to offer you the broadest and most thorough coverage at the most competitive price.

The Reinard Agency... personalized service and competitive prices for over 60 years.

The Reinard Agency, Inc.
Insurance

• 349 Bustleton Pike • Feasterville, PA 19047 • 357-8600
• 231 Hampstead Circle • Wrennwood, PA 19096 • 642-2224
• 808 Berklehem Pike • Erdenheim, PA 19118 • 836-5181
• 409 Main Street • Red Hill, PA 19076 • 670-6264



YOUR DIRECT SOURCE FOR CONSTRUCTION MONEY

Flexible ♦ Responsive ♦ Experienced

- ♦ Construction loans from \$100,000
- ♦ Competitive rates and terms
- ♦ Loan flexibility as a non-bank lender
- ♦ Incomparable closing and processing responsiveness
- ♦ Spot lot construction or entire development

"A full service mortgage banker building quality relationships by responding to the financial needs of the Pennsylvania home builder."

Call **Evan Eckert** at **(610) 668-1001**

INDEPENDENT
MORTGAGE COMPANY™

50 MONUMENT ROAD • BALA CYNWYD, PA 19004
PHONE (610) 668-1001 • FAX (610) 668-9264



OVER 40 YEARS OF QUALITY SERVICE

Light & Heavy Truck

Wheel Alignment
Front & Rear Axles
Featuring HUNTER COMPUTERIZED
Alignment Equipment

Complete Alignment
Benefits:

- Prolonged Tire Life
- Lower Operating Costs
- Safer Handling
- Less Driver Fatigue
- Better Straight-Line Stopping

WHEEL BALANCING

Tire rolling resistance has a major effect on fuel consumption.



GROW'S TRUCK SERVICE

563 Street Road
Southampton, Pa. 18966

(215) 322-9320
OFFICIAL STATE INSPECTION NO. 6620
ALL PENNSYLVANIA VEHICLES

HENRY J. MROZ
President

GROW'S TRUCK LEASING INC
Specializing In Full Maintenance Leasing

CATERPILLAR®
PARTS & SERVICE

PHOENIX
TRUCK EQUIPMENT

Meyer
PRODUCTS

STATE INSPECTION
ALL COMMERCIAL VEHICLES
TRAILERS & RV'S

HEAVY DUTY TOWING

• COMMERCIAL/FLEET
SERVICE & MAINTENANCE

• TRANSMISSIONS

• CLUTCHES

• DRIVELINES

• REARS & DIFFERENTIALS

Kendall
MOTOR OIL
POUR IN THE PROTECTION.

JASPER GO!
ENGINES & TRANSMISSIONS

PRECISION MACHINING

FROM THE BOTTOM OF THE SEA TO THE SURFACE OF THE MOON

Our clients are as diverse as our machining capability. Jenn has machined parts for submarines and the LEM (Lunar Excursion Module). We have earned the trust of manufacturers in a variety of industries including; Computer, Capital Goods, Analytical Instrumentation, Power Transmission and Aerospace.

Our experienced staff is expert at machining parts from wrought stock, extrusions, forgings and complex castings in materials as dissimilar as aluminum, exotic alloys, magnesium, composites and plastic.

If your part is as small as a cubic inch or as large as five by three feet and you need quantities from tens to tens of thousands, Jenn's high performance, "state of the industry" CNC machining centers and lathes supported by a Total Quality Management System ensure delivery of Perfect Parts, On Time, Every Time.

**After all, isn't that what
your company expects?**

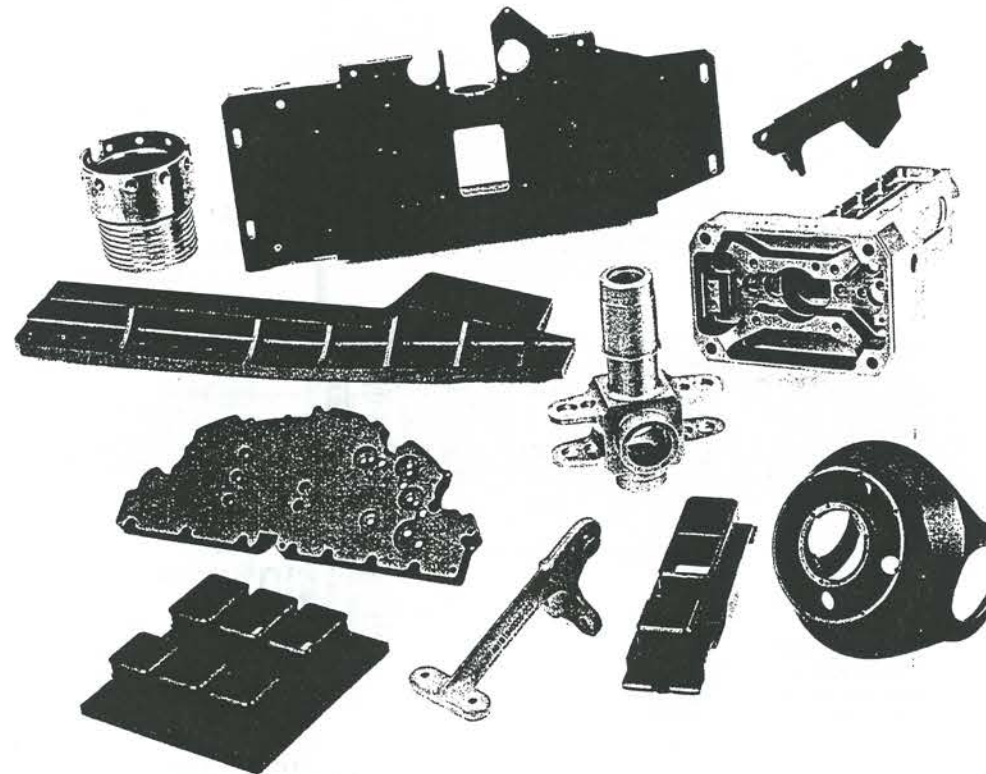

Precision CNC Machining and Assembly

DONALD RANK
Vice President Operations

1060 Louis Drive
Warminster, PA 18974

Tel: (215) 672-5800
Fax: (215) 672-1496



Precision CNC Machining and Assembly

LAWRENCE MURPHY
Director
Manufacturing Engineering

1060 Louis Drive
Warminster, PA 18974

Tel: (215) 672-5800
Fax: (215) 672-1496

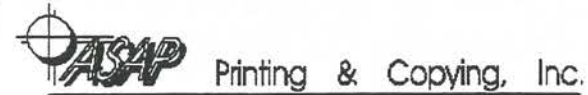

*Just One Stop For
All Of Your Printing Needs!*

- Offset Printing
- Xerox Docutech Copier
- Typesetting
- Bindery
- Color Xerox

Phone: (215) 357-5033
Fax: (215) 364-4716
1300 Industrial Highway
Southampton, PA 18966

RAY HEFFENTRAGER, INC.

Excavating • Grading • Hauling
Septic Systems • Driveways•



BILL HEFFENTRAGER
RICK GEFFENTRAGER

1440 Sleepy Hollow Road
Quakertown, PA 18951
(215) 679-5676

The Law Offices of Cordes & King, L.L.P.



27 South State Street
Newtown, Pa., 18940
(215)968-2248

28 W. Bridge Street
New Hope, Pa., 18938
(215)862-9461

507 S. 2nd Street
Philadelphia, PA 19147
215-923-8688

146 W. State Street
Doylestown, PA 18901
215-348-8338

EYEWORKS PLUS
Dr. Wm. Jay Troppauer

HOURS: MON - SAT: By appointment
EYE EXAMINATIONS
CONTACT LENSES
QUALITY GLASSES

LEONARD S. ADAMUSKO AGENCY



* AUTO * LIFE * FIRE *
* HEALTH * BUSINESS *
119 S. State Street, Newtown, PA 18940



Bus: (215) 968-9271
Fax: (215) 860-1620

COUNTRY TAVERN & RESTAURANT

Steak & Seafood House

SUNDAY NIGHT
Traditional Turkey Dinner
Served 3 - 10 PM \$4.95

EVERY WEDNESDAY & SATURDAY NIGHT
All You Can Eat Crab Legs \$16.95

- STEAMERS - CAJUN SHRIMP -
- OVERSTUFFED SANDWICHES -
- HANDCUT STEAKS - FRESH CUT FISH -

LIVE ENTERTAINMENT
EVERY FRIDAY & SATURDAY 10 PM

- CHILDREN'S MENU AVAILABLE
- DAILY LUNCH & DINNER SPECIALS
- AREA'S BEST SOUP & CHILI

Route 611 (2 Miles N. of Doylestown)
Plumsteadville
766-8981



A Professional Corporation

STYER ASSOCIATES
CERTIFIED PUBLIC ACCOUNTANTS

SOUDERTON OFFICE
P.O. Box 80 • 20 South School Lane • Souderton, PA 18964
Phone: (215) 723-0974 • Fax: (215) 723-1013



Thomas L. Newman, CFP
Vice President - Investment Officer
PRIVATE CLIENT GROUP

Wheat First Union
200 South Clinton Street
Doylestown, PA 18901
215 230-2892
1 800 666-2671
Fax 215 348-7035

Wheat First Union is a division of
Wheat First Securities, Inc., Member NYSE/SIPC

PERKASIE BOROUGH AUTHORITY

Providing Water and Sewer Services

in the Perkasie/East Rockhill Area.

SINCE 1895

Water Is Our Life Line.

Please Conserve It.

306 N. 5th Street,
Perkasie, PA

257-3654
8:00-4:30 p.m. Daily

HAPP CONTRACTORS, INC.
GENERAL CONTRACTOR

Building To Suit Your Needs "Since 1928"

- Light Industrial
- Commercial
- Professional Offices
- Historic Preservations
- Additions/Renovations
- Residential

260 W. ASHLAND ST.
P.O. BOX 835, DOYLESTOWN, PA 18901
215-348-9036 • FAX: 348-2798

Conveniently Yours



Bristol (Main Office)
118 Mill Street
Bristol, PA 19007-0032
788-3344

Bensalem
2127 Galloway Road
639-3500

Langhorne
126 S. Bellevue Avenue
757-5138

Hours
Mon-Thurs
9am-4pm
Fri 9am-5pm
Sat 9am-Noon

Extended
Drive-up hours
at select offices

Levittown
Levittown Shopping Center
946-7400

16 Highland Park Way
949-3900

New Hope
275 W. Bridge Street
862-5021

Wrightstown
Routes 232 & 413
598-3178

An Employee
Owned Company



We Deliver
Customer Satisfaction

"Serving the Healthcare Community Since 1968"

*Physicians, Nursing Homes, Clinicians, Therapists, Assisted Living Facilities,
Healthcare Professionals, Industry and People at Home.*

We do have....

- A full line of Medical Equipment and Supplies.
- Sales, Rentals and Repairs.
- Surgical / Treatment Supplies, Equipment and Furniture.
- Incontinent Supplies: Adult Briefs, Liners, Underpads, Wipes.
- Nutritional Supplements: Ensure, Ensure Plus.....
- Bathroom Safety Products: Toilet Seat Raisers, Grab Bars....
- Wheelchairs, Scooters, Lift Chairs, Walkers, Commodes, Beds.
- Oxygen and Respiratory Equipment and Supplies.
- Insurance Claim Filing.
- **FREE DELIVERY AND INSTRUCTION**

Over 14,000 products to choose from !!

Delcrest

Voted 1st Place By
The Intelligencer Record
Readers



For The Category Of
Medical Supplies
In The Bucks Mont Area

Medical Products

"An Employee Owned Company"

100 Commerce Drive
Ivyland, PA 18974

Phone: 215-675-4444

Fax: 215-675-1128

Web Site: www.delcrestmedical.com
e-mail: medical@delcrestmedical.com



CP COMMERCIAL PRINTING, INC.

If you are a new customer and you mention this ad, we will give you a two-color printing job, for the price of one. This offer is for in-house printing only. This offer includes: Letterheads, Envelopes, Carbonless Forms, Flyers, Brochures & Business Cards

Please call for details: (215) 675-7605

CP COMMERCIAL PRINTING, INC.



2031 Stout Drive • Warwick Commons
Warminster, PA 18974

*"Your Community's Printer
for
Our Community's Athletes"*

Tinari Container Service, Inc.

8, 12, 15, 20, 30, YD. CONTAINERS



SUSAN TINARI
1060 Industrial Blvd.
Southampton, PA 18966

215-322-9135
215-322-0664
Fax 215-322-9158

(215) 672-7660

TERENCE P. FENNINGHAM

SCHNEIDER, NIXON & JOHN
ATTORNEYS-AT-LAW

76 BYBERRY AVENUE
P.O. BOX 698
HATBORO, PA 19040



(215) 355-4946
(215) 355-9050
(Fax) (215) 355-9567

Joan Aichele
Manager

Pennridge Beverage

113 S. Second St.
Perkasie, PA 18944
215-257-2626

Mon. - Wed...9-8
Thursday.....9-8
Friday.....9-9
Saturday.....9-9

A. L. A.

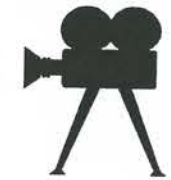

ATHLETIC
VIDEOS

215-348-3583

* SCHOOLS * COMPANIES * CORPORATIONS * SPORT TEAMS * SCHOOL TEAMS * PARTIES *

HIGH FIDELITY

SCREEN PRINTING

FOR ALL YOUR SCREEN PRINTING NEEDS

Specializing in T-Shirts, Sport Bottles,
Jackets, Refrigerator Magnets, Hats,
Roll Bags, Sweatshirts & Much More.
Fast Quality Service

(215) 957-6650

11 YORK RD. WARMINSTER



* SPECIAL EVENTS * CHURCHES * ORGANIZATIONS * FUND RAISERS * RETAILERS *

JOSEPH B. FINLAY, JR.

ATTORNEY AT LAW

LEDGEWOOD LAW FIRM
A PROFESSIONAL CORPORATION
1521 LOCUST STREET
PHILADELPHIA, PA 19102

(215) 790-2389
FAX (215) 735-2513
jfinlay@ldgwood.com

GO
BUCKS!!

RISTORANTE
SORRENTO
PIZZERIA



The Official Pizza of C.B. West

524 East Butler Avenue
New Britain, PA 18901
215-340-1133



Frances J. Hunter
REALTOR® GRI, ABR
With an accent on service.



RE/MAX
Properties, Ltd.
Independently Owned and Operated

263 N. Main Street
Doylestown, Pennsylvania 18901
Office: (215) 340-7844
Residence: (215) 766-2774
FAX: (215) 340-7840
fhunter396@aol.com



Food

Cocktails

Carmen's Place

Lunch-Dinner

364-2462

3971 Brownsville Road
Trevose, PA 19053



COMPLETE AUTO REPAIR SERVICE

Kar ELECTRONIC
Klinik DIAGNOSTIC
CENTER



- PA Safety Inspection
- Emission Inspection and Repair
- Diagnostic and Tune Up Service
- Complete Brake and Exhaust Service
- Tires, Batteries and Accessories
- Computer Wheel Balance
- Towing and Road Service

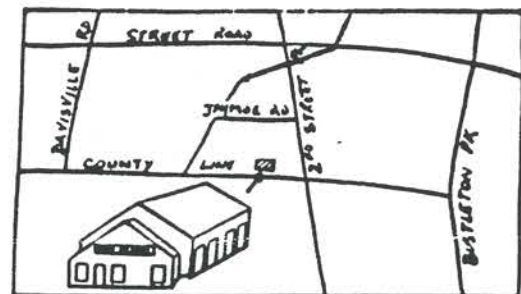

We employ technicians certified by the National Institute for
AUTOMOTIVE SERVICE EXCELLENCE
Let us show you their credentials

901 County Line Road • Huntingdon Valley, PA 19006 (one block West of 2nd Street Pike)

FOR AN APPOINTMENT — CALL 322-1776

355-2200

FAX 355-7162

STAHL & DAVIS INC.

General Contractors - Builders - Developers

SUITE 100
283 SECOND STREET PIKE
SOUTHAMPTON, PA 18966

Stahl-Campbell Realtors
283 Second Street Pike - Suite 100
Southampton, PA 18966

PAUL J. STAHL, JR
THOMAS J. CAMPBELL
Brokers

Tel. (215) 355-7100
FAX 355-7162

**Stahl -
Campbell**
REALTORS



**KIWANIS Club of
Southampton, PA, Inc.**

KIWANIS CLUB OF SOUTHAMPTON FOUNDATION, INC.
P.O. BOX 114 • Southampton, Pennsylvania 18966

Paul Cornell, President
Marty Schaeffer, Secretary



475 Spring Meadow Circle
New Hope, PA 18938

CHARLES R. MONAHAN

598-8078

- INSTALLATIONS & PHONE MOVING
- WIRING & JACKS
- RESIDENTIAL - COMMERCIAL

20 YEARS EXPERIENCE ON TELEPHONE EQUIPMENT
50% LESS THAN TELEPHONE RATES

Expert Alterations

Shirt Laundry

HAMPTON CLEANERS

Peter Di Pietro

Southampton, PA
(215) 357-4800

Jamison, PA
(215) 491-0440

**Good Luck Bucks
All Stars
From
Lion Paul Gunther
Lioness Kay Gunther
Southampton Club**



Telephone: (215) 561-0960
FAX: (215) 561-3827

**LAW OFFICES
OF
RONALD ZIEGLER**

ATTORNEY AT LAW

NINTH FLOOR
100 N. 17TH STREET
ROBERT MORRIS BUILDING
N.W. CORNER 17TH & ARCH STS.
PHILADELPHIA, PENNSYLVANIA 19103

**RE/MAX
Elite**

*Your Realtor
For
Bucks and montgomery
Counties*

Town and Country Center
483 E. County Line Road
Hatboro, PA 19040

328-4800

Gary K. Lucas
Broker/Owner
Southampton Lions Club Member

Call us for your **Selling** or **Buying** Questions!

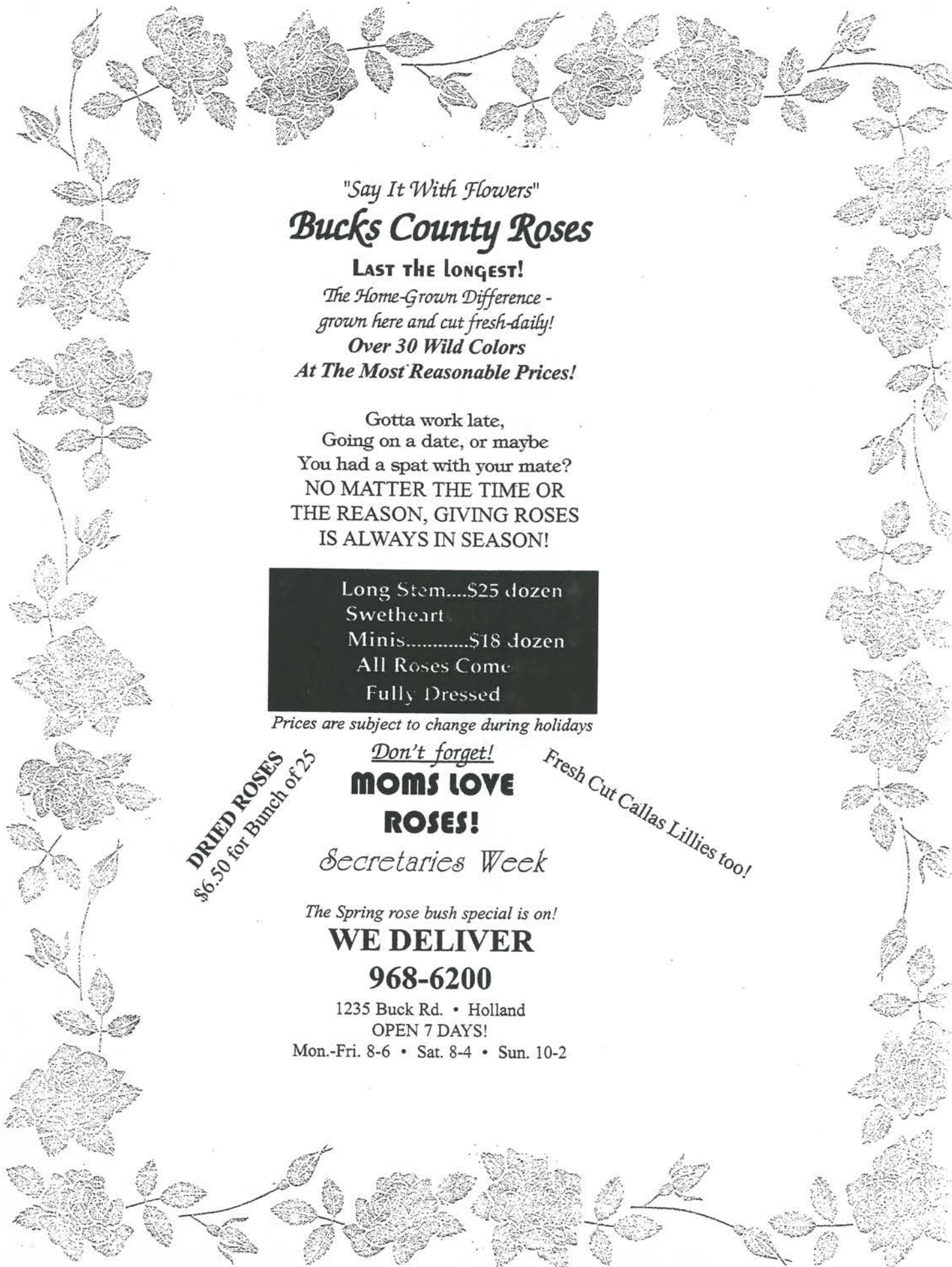

"Say It With Flowers"

Bucks County Roses

LAST THE LONGEST!

*The Home-Grown Difference -
grown here and cut fresh-daily!*

Over 30 Wild Colors

At The Most Reasonable Prices!

Gotta work late,
Going on a date, or maybe
You had a spat with your mate?
**NO MATTER THE TIME OR
THE REASON, GIVING ROSES
IS ALWAYS IN SEASON!**

Long Stem....\$25 dozen
Sweetheart
Minis.....\$18 dozen
All Roses Come
Fully Dressed

Prices are subject to change during holidays

DRIED ROSES
\$6.50 for Bunch of 25

Don't forget!
**MOMS LOVE
ROSES!**

Secretaries Week

The Spring rose bush special is on!

WE DELIVER

968-6200

1235 Buck Rd. • Holland

OPEN 7 DAYS!

Mon.-Fri. 8-6 • Sat. 8-4 • Sun. 10-2

Fresh Cut Callas Lillies too!

Committed to the Community

Totally Free Checking? Just ask us!

Visit one of our convenient locations today!

Newtown Office

Tower Center
Terry Drive & Newtown-Yardley Rd.
Newtown, PA 18940
(215) 504-5501

Yardley Office

95 S. Main St.
Yardley, PA 19607
(215) 493-2180

Washington Crossing Office

Rt. 532 & Taylorsville Rd.
Washington Crossing, PA 18977
(215) 493-9100

Doylestown Office

Mercer Square Shopping Center
73 Old Dublin Pike
Doylestown, PA 18901
(215) 345-6995

Langhorne Office

102 N. Flowers Mill Road
Langhorne, PA 19047
(215) 757-2222

www.sovereignbank.com

 **Sovereign Bank**

Member FDIC

SMITH BARNEY

THE SPIOPOULOS GROUP

OF SMITH BARNEY

A professional financial practice
specializing in serving
successful individuals and corporations
with consulting and
investment advisory services.

THE
SPIOPOULOS
GROUP

114 South State Street
Newtown, PA 18940

(215) 968-0900

(800) 245-1559

WILLIAM T. SPIOPOULOS JOHN K. WHITEHEAD
MATTHEW POPRIK MAUREEN GRILL VIRGINIA CONIGLIO

Member New York Stock Exchange and SIPC